

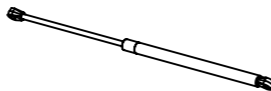

SPARE PARTS GUIDE

ITEM NO.	DESCRIPTION	PART #	REFERENCE IMAGE
1	GAS STRUT - 300N, 200mm STROKE	G300	
2	SLAMSTOP (200mm STROKE)	SLM-200	
3	LOCK - PAIR OF 5-LEVER DEADLOCK, COMES WITH 4 KEYS	LOCK-DL2	
4	BOLT- M5X16 SOCKET COUNTERSUNK SCREW, ZINC PLATED (HIGH TENSILE GRADE 10.9)	BLT-M5X16-H	
5	INDEX PLUNGER - METAL BODY, 24mm HEAD DIAMETER, M12 X 1.75mm THREAD, 7mm PLUNGER PIN DIAMETER	IDX-PGR-M12	
6	WASHER - FLAT M27, BZP STEEL	WAS-M27-F	
7	WASHER - STAR CAP CLOSED RETAINER M25, (FOR AXLES)	WAS-M25-C	
8	WHEEL - 300MM BLACK RUBBER ON RED POLYPROPYLENE, 280KG CAPACITY	WHL300	

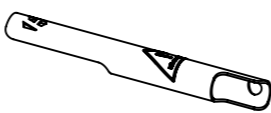
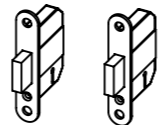
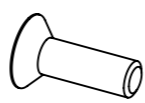
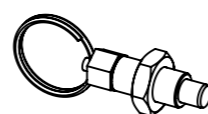
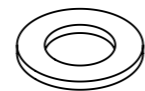
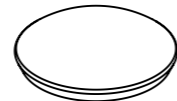

PRODUCT NAME:
BARROBOX - BB2

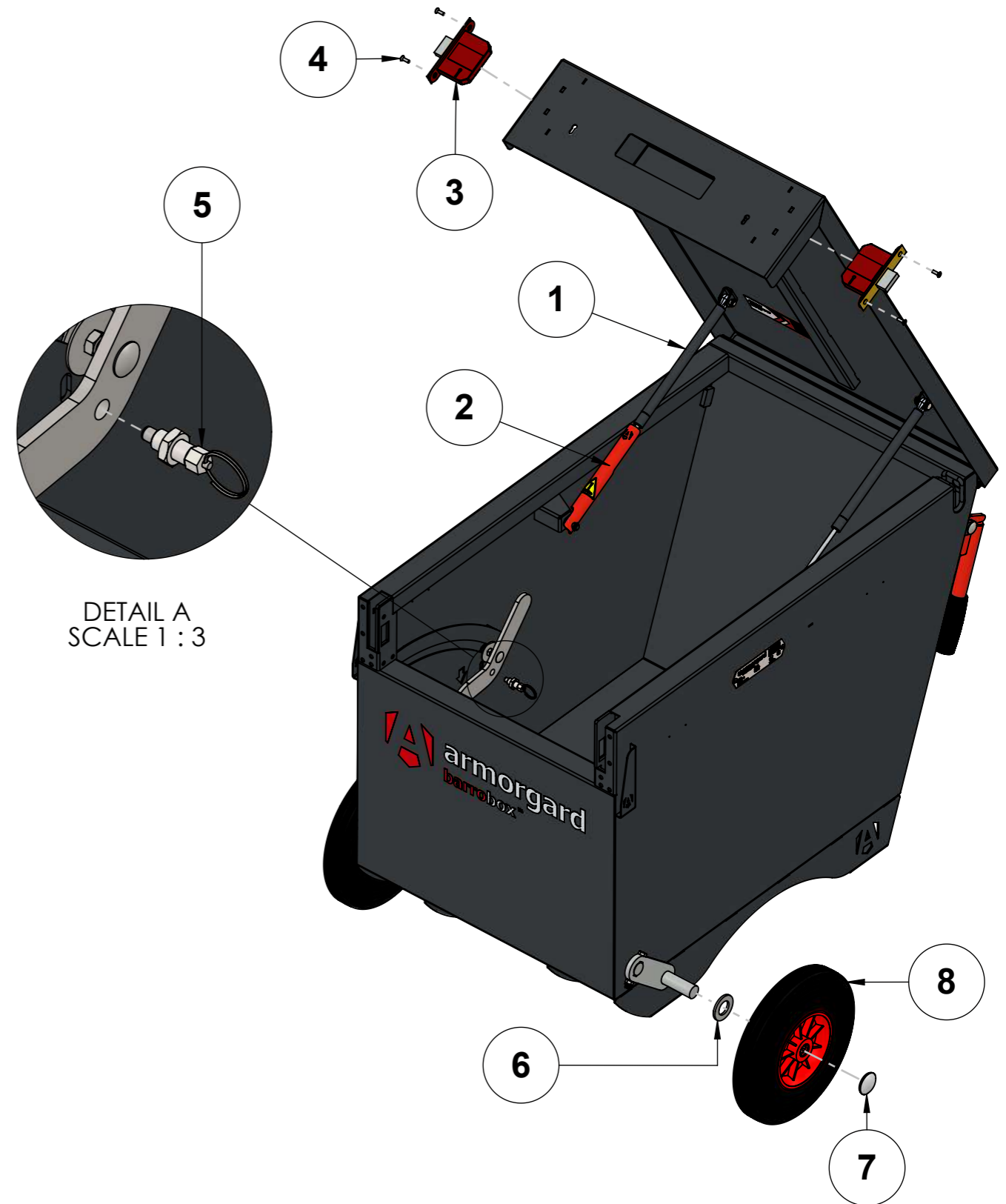
PRODUCT VERSION:
P02

WEIGHT:
86KG

NOTES:

LAST DATE SAVED:

15/10/2025

THIS DRAWING MAY NOT BE COPIED, PUBLISHED OR TRANSMITTED TO A THIRD PARTY WITHOUT THE PRIOR WRITTEN CONSENT OF ARMORGARD LIMITED.

SPARE PARTS GUIDE

PRODUCT COLOUR:
RAL7021 DARK GREY

LEAD TIMES MAY VARY – PLEASE ENQUIRE

PAGE 1 of 1