

SPARE PARTS GUIDE

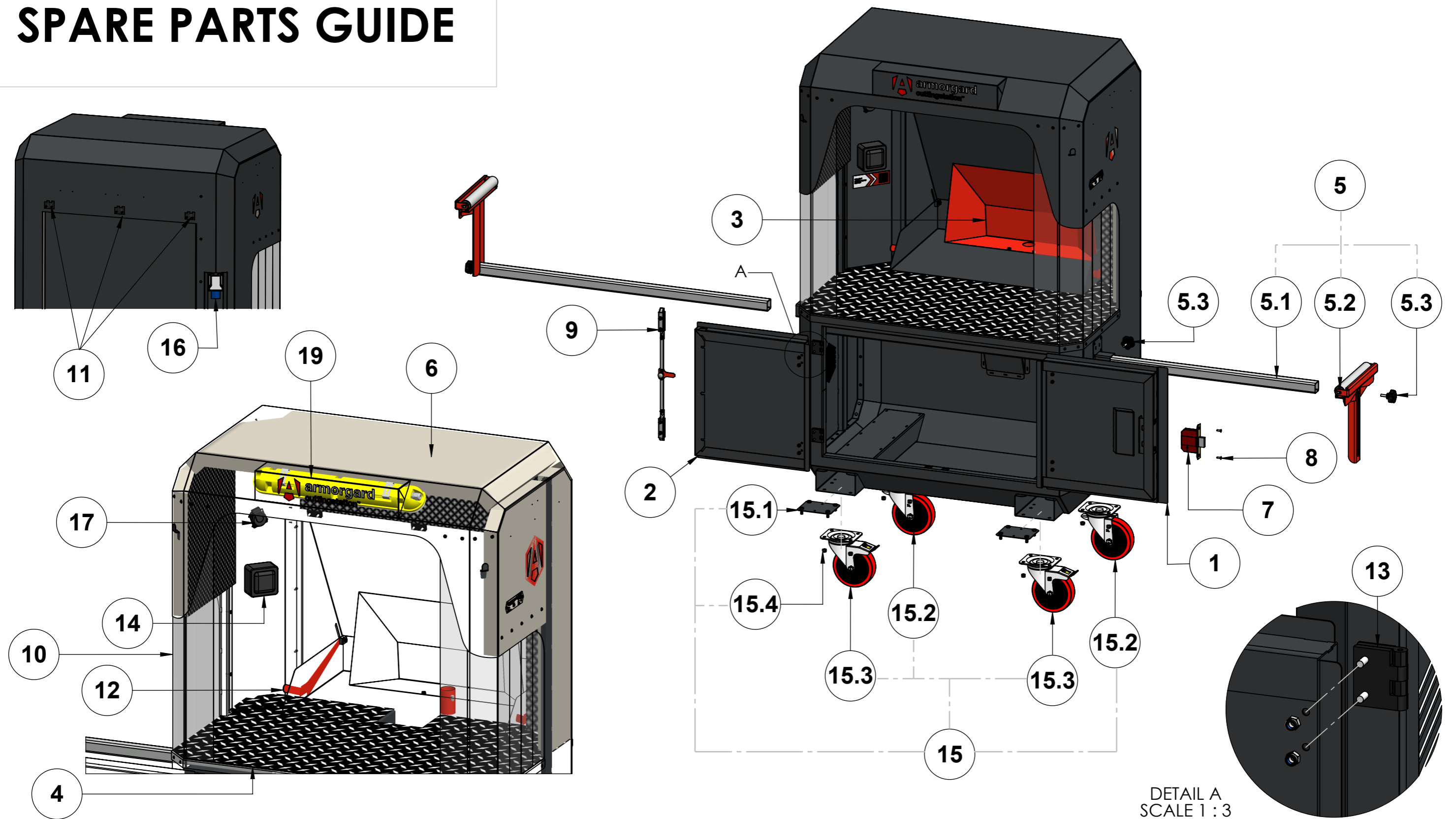

PRODUCT NAME:
CUTTING STATION SS7EU

PRODUCT VERSION: P04
WEIGHT: 200KG

NOTES:

LAST DATE SAVED:
17/12/2025





THIS DRAWING MAY NOT BE COPIED, PUBLISHED OR TRANSMITTED TO A THIRD PARTY WITHOUT THE PRIOR WRITTEN CONSENT OF ARMORGARD LIMITED.





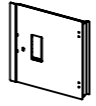
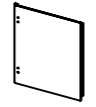
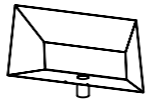
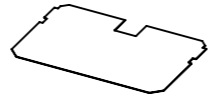

SPARE PARTS GUIDE

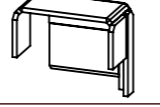
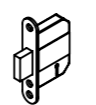
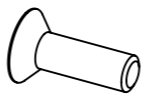
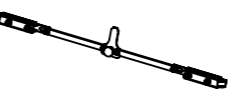
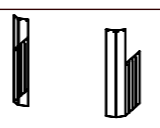
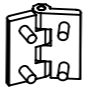
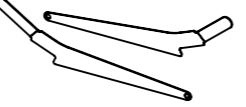
PRODUCT COLOUR:
RAL7021 DARK GREY

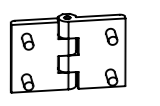
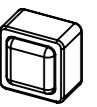
LEAD TIMES MAY VARY – PLEASE ENQUIRE

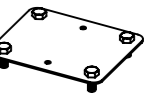
PAGE 1 of 2

ITEM NO.	DESCRIPTION	PART #	REFERENCE IMAGES
1	CUTTINGSTATION SS7-RHD RIGHT REPLACEMENT DOOR, EXCLUDES HINGES AND LOCKS	SS7-RHD	
2	CUTTINGSTATION SS7-LHD LEFT REPLACEMENT DOOR, EXCLUDES HINGES AND LOCKS	SS7-LHD	
3	CUTTINGSTATION SS7-RRH REPLACEMENT REAR HOPPER	SS7-RRH	
4	CUTTINGSTATION SS7-MATK RUBBER MAT	SS7-MATK	
5	CUTTINGSTATION SS7-SAK SUPPORT ARM KIT FOR ONE SIDE, COMES WITH 1X SUPPORT ARM, 1X SUPPORT ARM ROLLER, 1X MATERIAL SUPPORT V-FRAME AND END FRAME, 1X MATERIAL SUPPORT T-FRAME, 1X M10X30MM STAR SCREW	SS7-SAK	
5.1	CUTTINGSTATION SS7-SA10 SUPPORT ARM WITH M10 THREADED INSERT; ONLY COMPATIBLE WITH MATERIAL SUPPORT FRAME THAT HAS 10mm SLOT	SS7-SA10	
5.2	CUTTINGSTATION SS7-MSK MATERIAL SUPPORT KIT FOR ONE SIDE, COMES WITH 1X SUPPORT ARM ROLLER, 1X MATERIAL SUPPORT V-FRAME AND END FRAME, 1X MATERIAL SUPPORT T-FRAME	SS7-MSK	
5.3	M8 X 25mm STAR HANDLED CLAMPING SCREW OR M10 X 30mm STAR HANDLED CLAMPING SCREW - PLEASE CHECK	SCR-M8X25-STR OR SCR-M10X30-STR	
6	CUTTINGSTATION SS7-FOAMK SOUND DEADENING FOAM KIT	SS7-FOAMK	
7	LOCK - SINGLE 5-LEVER DEADLOCK, COMES WITH 3 KEYS	LOCK-DL1	
8	BOLT- M5x16 SOCKET COUNTERSUNK SCREW, ZINC PLATED (HIGH TENSILE GRADE 10.9)	BLT-M5x16-H	
9	CUTTINGSTATION SS7-LTC LATCH SET, COMES WITH SLAM LATCHES, RODS AND FIXINGS	SS7-LTC	
10	CUTTINGSTATION SS7-CUR P01 CURTAIN SET, COMES WITH 2X PVC MULTI-STRIPS 380W X 525H, 4X PVC STRIPS 95W X 875H	SS7-CUR	
11	HINGE - M5 BOLT-ON, ALUMINIUM, BLACK 40mm	HNG-40B	
12	CUTTINGSTATION SS7-RBL REPLACEMENT BACK LEVER KIT, COMES WITH 1X RIGHT LEVER, 1X LEFT LEVER, 2X M6X16 HEX SET SCREW, 2X M6 SPRING WASHER, 2X M6 SLEEVE NUT	SS7-RBL	

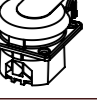
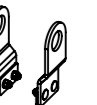
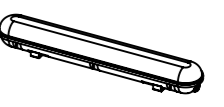
ITEM NO.	DESCRIPTION	PART #	REFERENCE IMAGES
13	HINGE - M6 BOLT-ON, ALUMINIUM, BLACK 76mm	HNG-76B	
14	10A 1 GANG DOUBLE POLE SWITCH IP66 - UK/EU	SWT-01	
15	CASTOR SET - 160mm RED HD WHEELS: 2X SWIVEL BRAKED, 2X SWIVEL; 4X CASTOR PLATES, 16X M8 NYLOCS	CASHD2	
15.1	CASTOR FIXING PLATE (105MMX80MM HOLE CENTRES)	CAS-CP	
15.2	CASTOR - 160mm RED HD RUBBER ON NYLON, SWIVEL BRAKED, 350KG CAPACITY	CAS160HD-SS-SB	
15.3	CASTOR - 160mm RED HD RUBBER ON NYLON, SWIVEL, 350KG CAPACITY	CAS160HD-SS-SW	
15.4	FIXING KIT - COMES WITH 16X M8 NUTS	M8-NUT-KIT	
16	APPLIANCE INLET 240V 16A BLUE	A1240V-16	
17	16A 240V SCHUKO CAPPED SOCKET IP54	SOC-240-SCHUKO	
18	CERTIFIED LIFTING EYE KIT - COMES WITH 2X LIFTING EYES, 2X PLATES AND FIXINGS	CLEK2	
19	LIGHT - 110V LED NCF IP65 600mm	LED600	
20	CUTTINGSTATION SS7C SAW CLAMP	SS7C	