

SPARE PARTS GUIDE

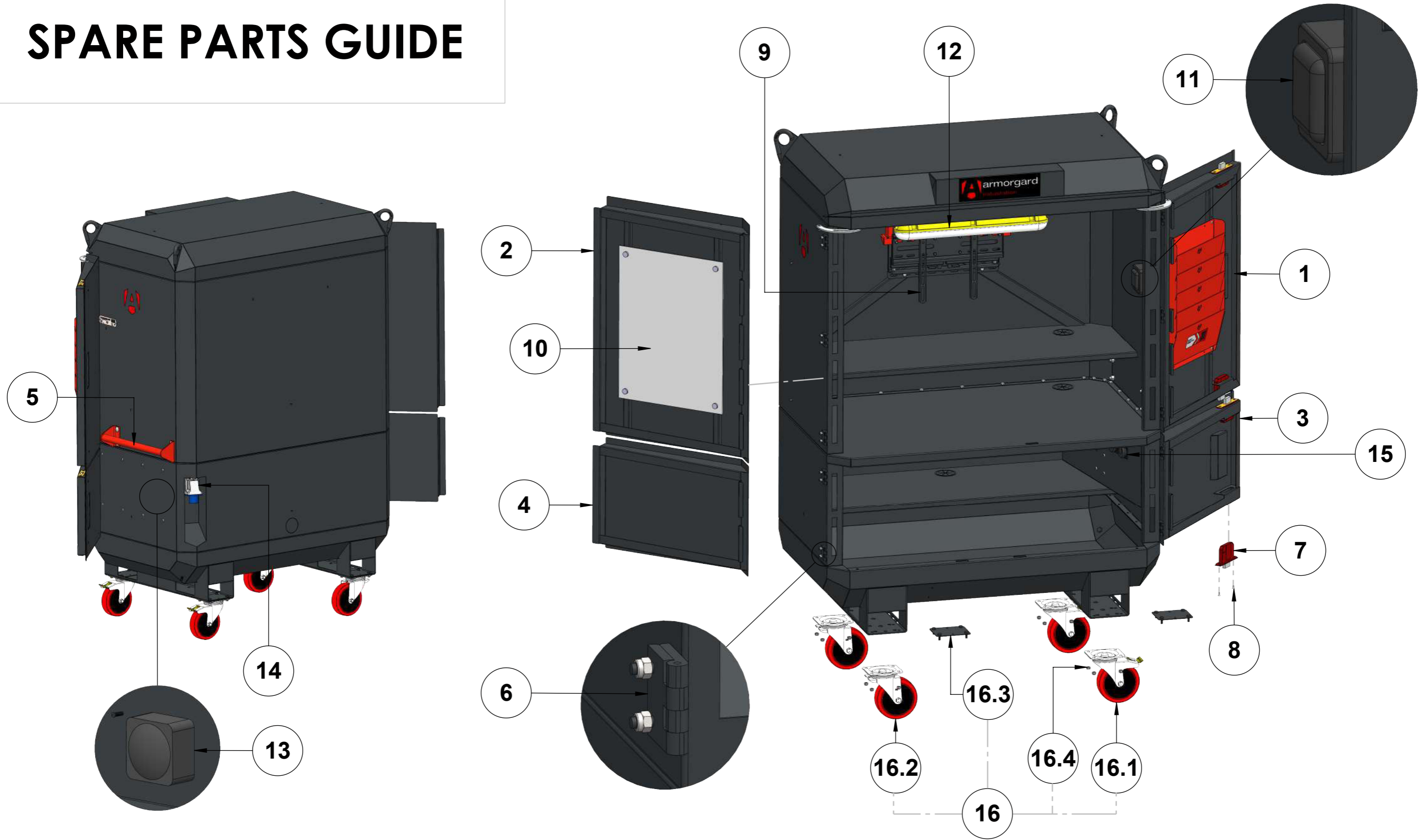

PRODUCT NAME:
DATASTATION - DS2-EU

PRODUCT VERSION:
P03

WEIGHT:
250KG

NOTES:

LAST DATE SAVED:

07/02/2025



THIS DRAWING MAY NOT BE COPIED, PUBLISHED OR TRANSMITTED TO A THIRD PARTY WITHOUT THE PRIOR WRITTEN CONSENT OF ARMORGARD LIMITED.







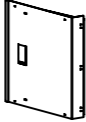

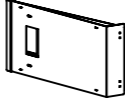
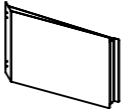
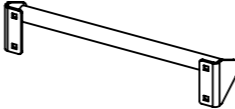
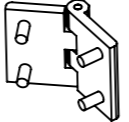
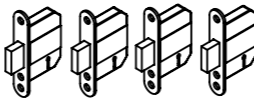
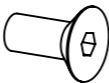
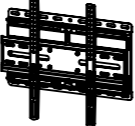
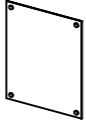
SPARE PARTS GUIDE

PRODUCT COLOUR:
RAL7021 DARK GREY

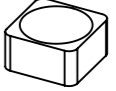
LEAD TIMES MAY VARY – PLEASE ENQUIRE

PAGE 1 of 2

ITEM NO.	DESCRIPTION	PART #	REFERENCE IMAGE
1	DATASTATION DS2-URHD UPPER RIGHT REPLACEMENT DOOR, BOLT-ON, EXCLUDES HINGES AND LOCKS	DS2-URHD	
2	DATASTATION DS2-ULHD UPPER LEFT REPLACEMENT DOOR, BOLT-ON, EXCLUDES HINGES AND LOCKS	DS2-ULHD	
3	DATASTATION DS2-LRHD LOWER RIGHT REPLACEMENT DOOR, BOLT-ON, EXCLUDES HINGES AND LOCKS	DS2-LRHD	
4	DATASTATION DS2-LLHD LOWER LEFT REPLACEMENT DOOR, BOLT-ON, EXCLUDES HINGES AND LOCKS	DS2-LLHD	
5	HANDLE - RED STEEL, BOLT-ON, EXCLUDES FIXINGS, 480W X 90D X 100H	HAN-480-B	
6	HINGE - M6 BOLT-ON, ALUMINIUM, BLACK, 76MM (EXCLUDES M6 NYLOCS)	HNG-76B	
7	LOCK - QUAD OF KEYED ALIKE 5-LEVER FORTRESS DEADLOCK, COMES WITH 8 KEYS	LOCK-DL4	
8	BOLT - M5X16 SOCKET COUNTERSUNK SCREW, ZINC PLATED (HIGH TENSILE GRADE 10.9)	BLT-M5X16-H	
9	WALL MOUNT - FOR DIGITAL SCREEN, SWIVEL-TILT FOR UP TO 55INCG, 45KG MAX WEIGHT	SCNMNT-55	
10	WHITEBOARD - 450 X 600MM	WB-600-450	

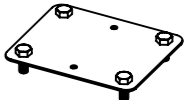
ITEM NO.	DESCRIPTION	PART #	REFERENCE IMAGE
11	SWITCH - 10A, 1 GANG DOUBLE POLE SWITCH, IP66 - UK/EU	SWT-01	
12	LIGHT - 110V LED NCF IP65 600mm	LED600	
13	JUNCTION BOX - BLACK, 32A, IP66 85X85X51MM	JB-1G	
14	APPLIANCE INLET 240V 16A BLUE	AI240V-16	
15	16A 240V SCHUKO CAPPED SOCKET IP54	SOC-240-SCHUKO	
16	CASTOR SET - 160mm RED HD WHEELS: 2X SWIVEL BRAKED, 2X SWIVEL; 4X CASTOR PLATES, 16X M8 NYLOCS	CASHD2	
16.1	CASTOR - 160mm RED HD RUBBER ON NYLON, SWIVEL BRAKED, 350KG CAPACITY	CAS160HD-SS-SB	
16.2	CASTOR - 160mm RED HD RUBBER ON NYLON, SWIVEL, 350KG CAPACITY	CAS160HD-SS-SW	
16.3	CASTOR - FIXING PLATE	CAS-CP	
16.4	FIXING KIT - COMES WITH 16X M8 NYLOCS	M8-NUT-KIT	