

SPARE PARTS GUIDE

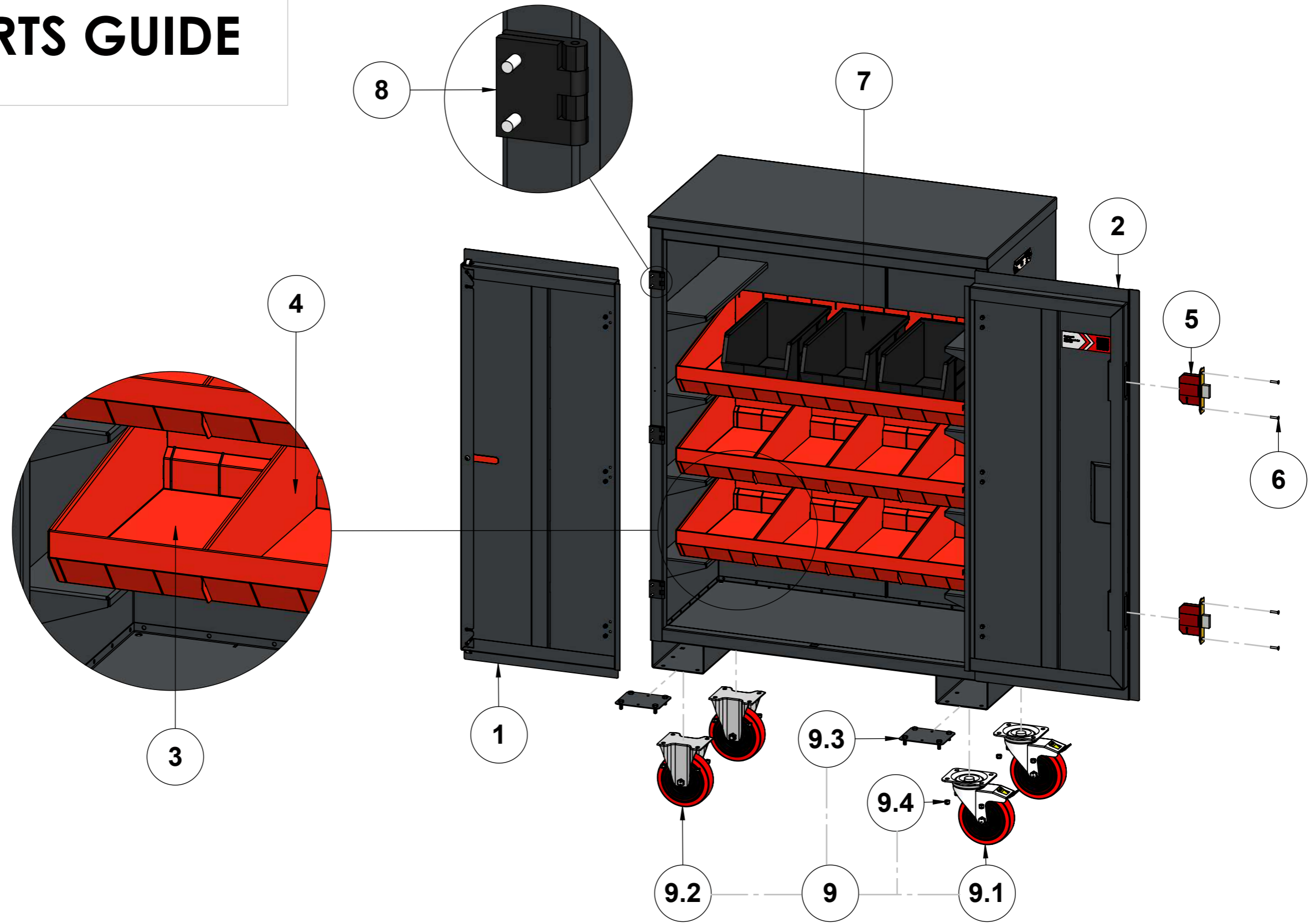

PRODUCT NAME:
FITTINGSTOR FC4

PRODUCT VERSION:
P01

WEIGHT:
140KG

NOTES:

LAST DATE SAVED:

11/02/2025









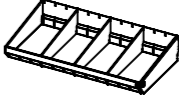

THIS DRAWING MAY NOT BE COPIED, PUBLISHED OR TRANSMITTED TO A THIRD PARTY WITHOUT THE PRIOR WRITTEN CONSENT OF ARMORGARD LIMITED.

SPARE PARTS GUIDE

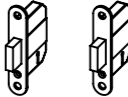
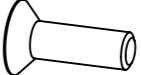
PRODUCT COLOUR:
RAL7021 DARK GREY

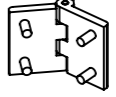
LEAD TIMES MAY VARY – PLEASE ENQUIRE

PAGE 1 of 2

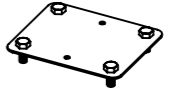
ITEM NO.	DESCRIPTION	PART #	REFERENCE IMAGE
1	FITTINGSTOR FC-LHD-B LEFT REPLACEMENT DOOR FOR FC3/FC4, BOLT-ON, EXCLUDES HINGES AND LATCHES	FC-LHD-B	
2	FITTINGSTOR FC-RHD-B RIGHT REPLACEMENT DOOR FOR FC3/FC4, BOLT-ON, EXCLUDES HINGES AND LATCHES	FC-RHD-B	
3	SHELF - POWDER COATED, COMES WITH ADJUSTABLE DIVIDERS FOR FC4	SHE-FC4	
4	SHELF - POWDER COATED, ADJUSTABLE DIVIDER FOR SHE-FC4	SHE-FC4-DIV	
5	LOCK - PAIR OF 5-LEVER DEADLOCK, COMES WITH 6 KEYS	LOCK-DL2	
6	BOLT- M5X16 SOCKET COUNTERSUNK SCREW, ZINC PLATED (HIGH TENSILE GRADE 10.9)	BLT-M5X16-H	
7	LIN BIN FOR FC RANGE 205X350X178	FCB	
8	HINGE - M6 BOLT-ON, ALUMINIUM, BLACK, 76MM (EXCLUDES M6 NYLOCS)	HNG-76B	
9	CASTOR SET-160MM RED HD WHEELS: 2X SWIVEL BRAKED, 2X FIXED; 4X CASTOR PLATES, 16X M8 NYLOCS	CASHD1	
9.1	CASTOR - 160mm RED HD RUBBER ON NYLON, SWIVEL BRAKED, 350KG CAPACITY	CAS160HD-SS-SB	
9.2	CASTOR - 160MM RED HD RUBBER ON NYLON, FIXED, 350KG CAPACITY	CAS160HD-SS-FX	
9.3	CASTOR - FIXING PLATE	CAS-CP	
9.4	FIXING KIT - COMES WITH 16X M8 NYLOCS	M8-NUT-KIT	