

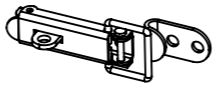

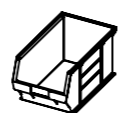



# SPARE PARTS GUIDE

ITEM NO.	DESCRIPTION	PART #	REFERENCE IMAGE
1	OVERCENTRE LATCH WITH HOOK PLATE ZINC PLATED 50X123X32	OCL-1	
2	LIN BIN FOR FC RANGE 205X350X178	FCB	
3	CASTOR SET - 160MM BLACK WHEELS: 4X SWIVEL BRAKED, 2X SWIVEL; 6X CASTOR PLATES, 24X M8 NYLOCS	CASS3	
3.1	CASTOR - 160MM BLACK RUBBER ON STEEL, SWIVEL, 135KG CAPACITY	CAS160-SS-SW	
3.2	CASTOR - 160MM BLACK RUBBER ON STEEL, SWIVEL BRAKED, 135KG CAPACITY	CAS160-SS-SB	
3.3	CASTOR - FIXING PLATE	CAS-CP	
3.4	FIXING KIT - COMES WITH 16X M8 NYLOCS	M8-NUT-KIT	

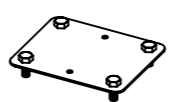

PRODUCT NAME:  
**FITTINGSTOR - FC5**

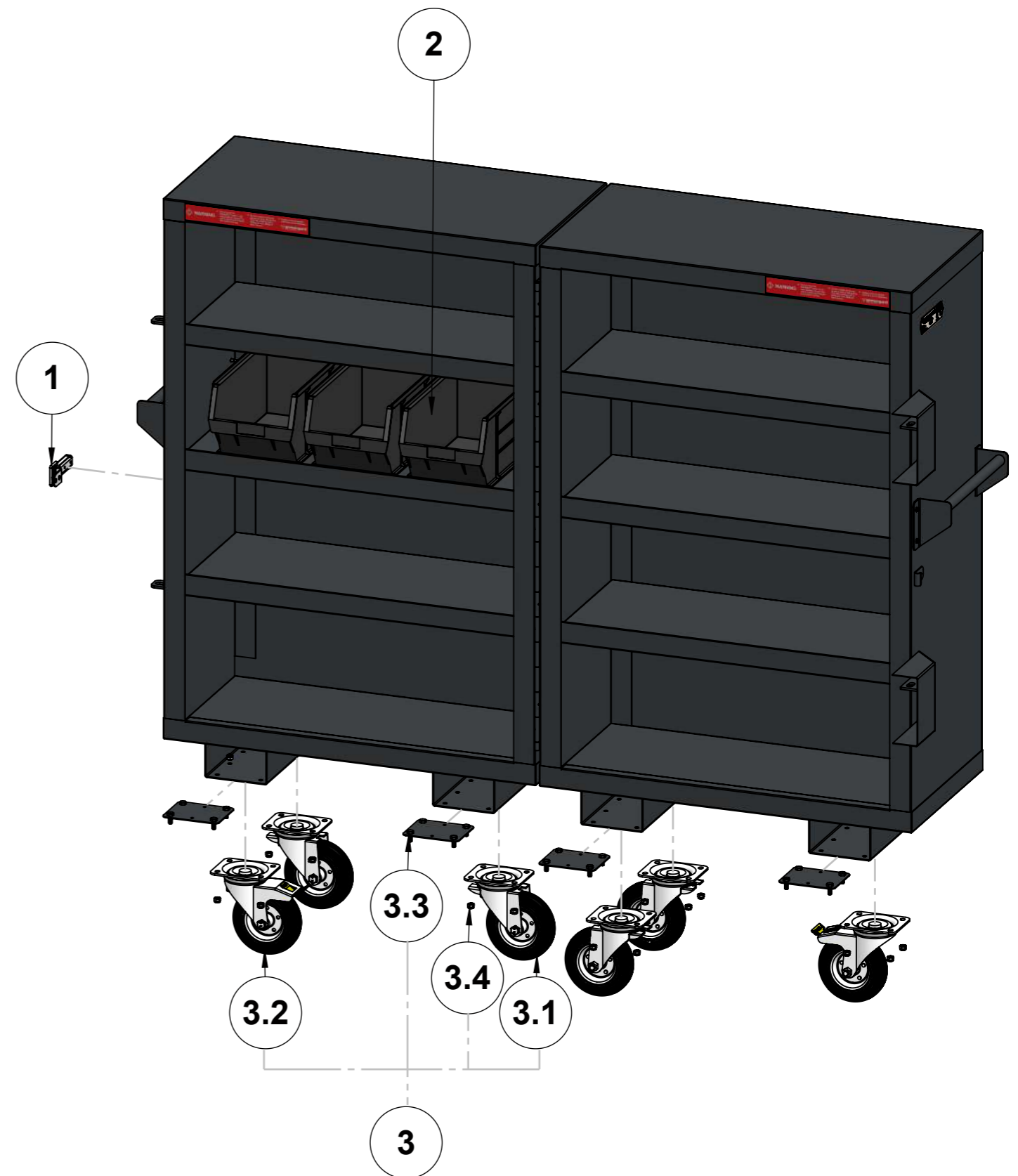
PRODUCT VERSION:  
P01

WEIGHT:  
156KG

NOTES:

LAST DATE SAVED:

12/02/2025

THIS DRAWING MAY NOT BE COPIED, PUBLISHED OR TRANSMITTED TO A THIRD PARTY WITHOUT THE PRIOR WRITTEN CONSENT OF ARMORGARD LIMITED.

SPARE PARTS GUIDE

PRODUCT COLOUR:  
RAL7021 DARK GREY

LEAD TIMES MAY VARY – PLEASE ENQUIRE

**PAGE 1 of 1**