

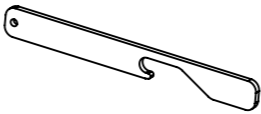

SPARE PARTS GUIDE

ITEM NO.	DESCRIPTION	PART #	REFERENCE IMAGE
1	LID STAY - SUPPORT STAY FOR TBC4, TBC5, FBC4, FBC5, FBC8	STAY2	
2	LOCK - PAIR OF 5-LEVER DEADLOCK, COMES WITH 4 KEYS	LOCK-DL2	
3	BOLT - M5X16 SOCKET COUNTERSUNK SCREW, ZINC PLATED (HIGH TENSILE GRADE 10.9)	BLT-M5X16-H	
4	1000N GAS STRUT (300MM STROKE)	G1000	
5	SHELF- GALVANISED, FOR FBC2	SHE-CH2	
6	CASTER SET - 160mm BLACK WHEELS: 2X SWIVEL BRAKED, 2X FIXED; 4X CASTER PLATES, 16X M8 NYLOCS	CASS1	
7	KEY - SINGLE, FOR DEADLOCK	KEY-1	
8	KEY - SET OF 3, FOR DEADLOCK	KEY-3	

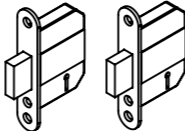
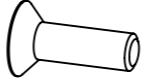
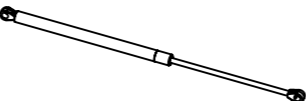

PRODUCT NAME:
FLAMBANK - FBC2

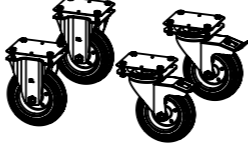
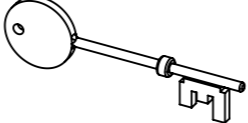
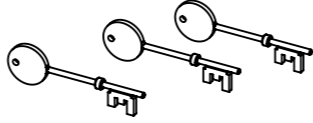
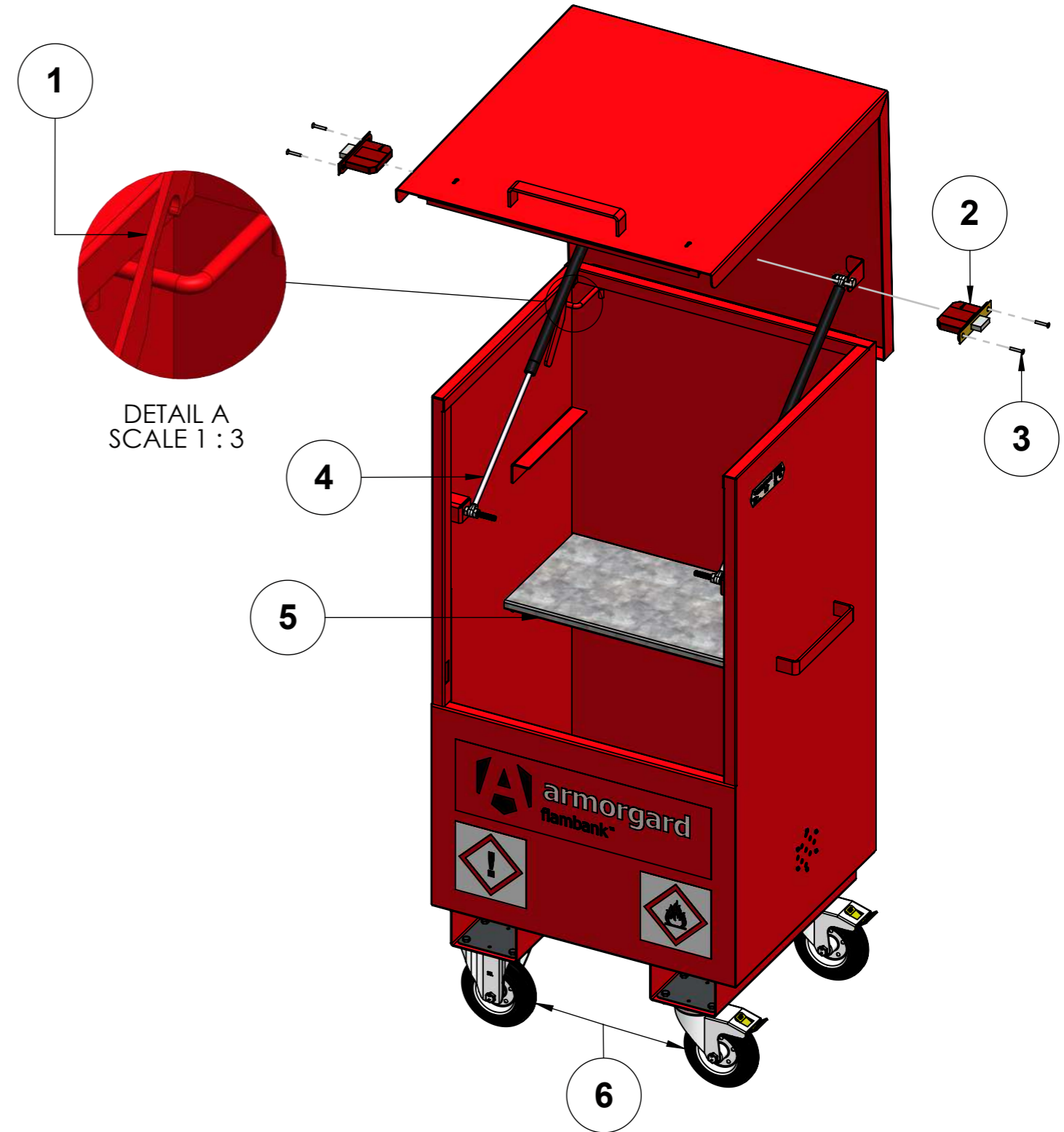
PRODUCT VERSION:
P01

WEIGHT:
110KG

NOTES:

LAST DATE SAVED:

22/11/2024

THIS DRAWING MAY NOT BE COPIED, PUBLISHED OR TRANSMITTED TO A THIRD PARTY WITHOUT THE PRIOR WRITTEN CONSENT OF ARMORGARD LIMITED.

SPARE PARTS GUIDE

PRODUCT COLOUR:
RAL3020 RED

LEAD TIMES MAY VARY – PLEASE ENQUIRE

PAGE 1 of 1