

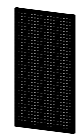

# SPARE PARTS GUIDE

ITEM NO.	DESCRIPTION	PART #	REFERENCE IMAGE
1	GORILLA GAS CAGE GGC-P3 PANEL 3 - 900W X 1800H	GGC-P3	
2	GORILLA GAS CAGE GGC-DB DOOR B - 900W X 1800H	GGC-DB	
3	GORILLA GAS CAGE GGC-Z Z-BRACKET	GGC-Z	
4	FIXING KIT - FOR GAS CAGES, COMES WITH 12X M8X65 HEX HEAD SCREWS, 12X M8 NYLOCS	GGC-FK1	
5	SIGN - HAZARDOUS GOODS CORREX SAFETY SIGN	SIGN-HAZ-SAFE	
6	SIGN - 'ARMORGARD' CORREX SAFETY SIGN	SIGN-AGD	

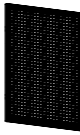
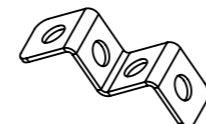
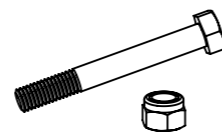
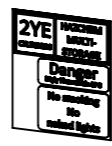

PRODUCT NAME:  
**GORILLA GAS CAGE - GGC11**

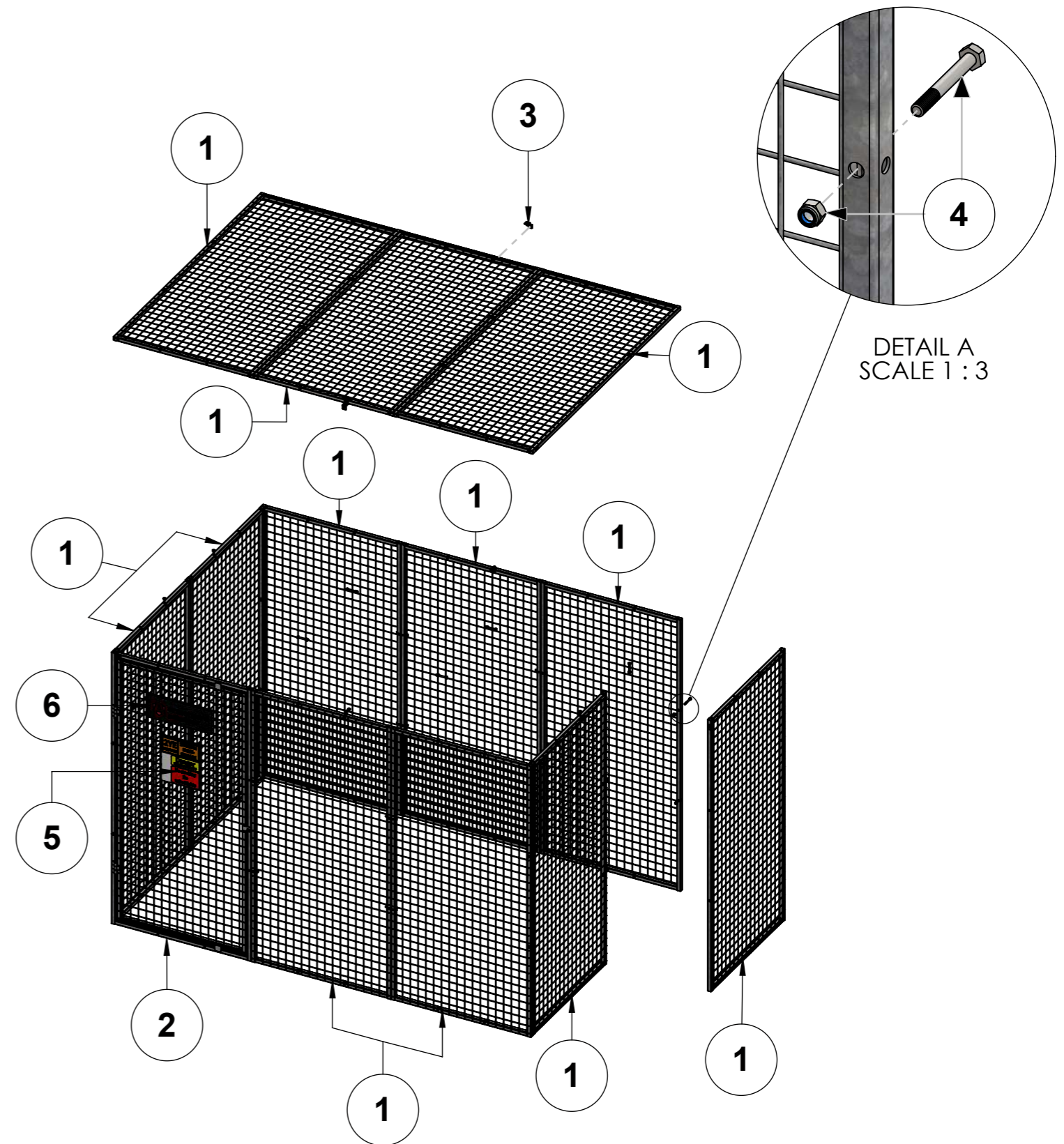
PRODUCT VERSION:  
P02

WEIGHT:  
148KG

NOTES:

LAST DATE SAVED:

14/11/2024

THIS DRAWING MAY NOT BE COPIED, PUBLISHED OR TRANSMITTED TO A THIRD PARTY WITHOUT THE PRIOR WRITTEN CONSENT OF ARMORGARD LIMITED.

SPARE PARTS GUIDE

PRODUCT COLOUR:  
GALVANIZED

LEAD TIMES MAY VARY – PLEASE ENQUIRE

**PAGE 1 of 1**