

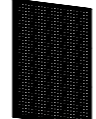

SPARE PARTS GUIDE

ITEM NO.	DESCRIPTION	PART #	REFERENCE IMAGE
1	GORILLA GAS CAGE GGC-P4 PANEL 4 - 1200W X 1200H	GGC-P4	
2	GORILLA GAS CAGE GGC-P6 PANEL 6 - 1200W X 1800H	GGC-P6	
3	GORILLA GAS CAGE GGC-DD DOOR D - 1200W X 1800H	GGC-DD	
4	GORILLA GAS CAGE GGC-Z Z-BRACKET	GGC-Z	
5	FIXING KIT - FOR GAS CAGES, COMES WITH 12X M8X65 HEX HEAD SCREWS, 12X M8 NYLOCS	GGC-FK1	
6	SIGN - HAZARDOUS GOODS CORREX SAFETY SIGN	SIGN-HAZ-SAFE	
7	SIGN - 'ARMORGARD' CORREX SAFETY SIGN	SIGN-AGD	

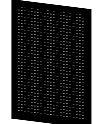
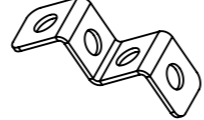
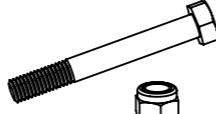

PRODUCT NAME:
GORILLA GAS CAGE - GGC14

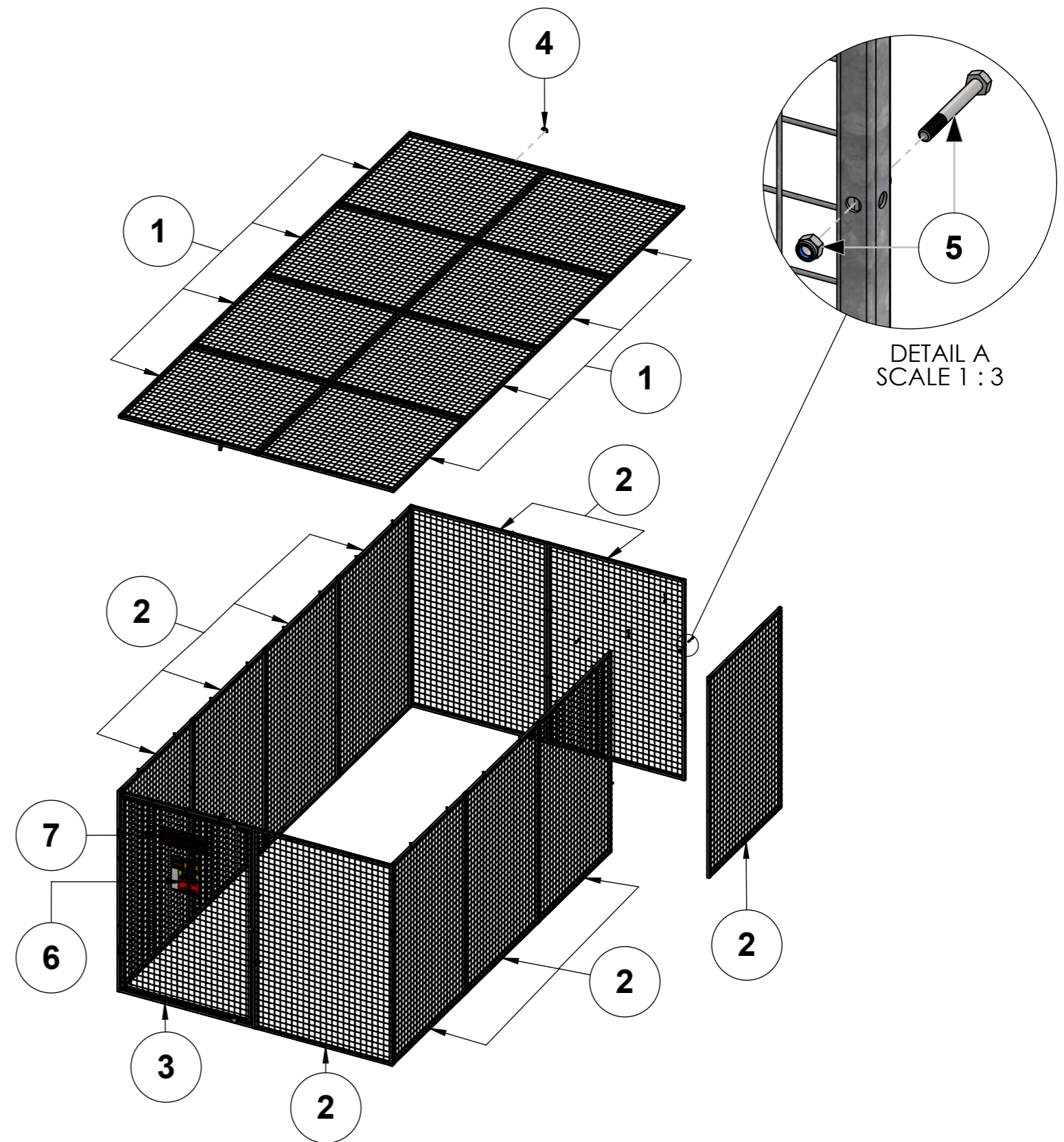
PRODUCT VERSION:
P02

WEIGHT:
238KG

PRODUCT COLOUR:
GALVANIZED

NOTES:

LAST DATE SAVED:

14/11/2024

THIS DRAWING MAY NOT BE COPIED, PUBLISHED OR TRANSMITTED TO A THIRD PARTY WITHOUT THE PRIOR WRITTEN CONSENT OF ARMORGARD LIMITED.

SPARE PARTS GUIDE

LEAD TIMES MAY VARY – PLEASE ENQUIRE

PAGE 1 of 1