

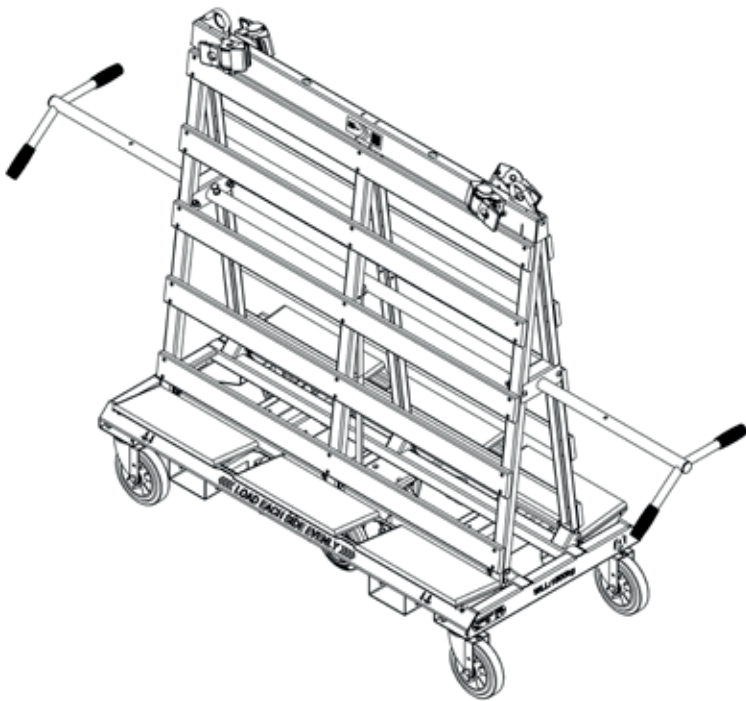

loadall™

Operational and maintenance manual

Suitable for: LA1500-PRO





Welcome

Welcome to your Armorgard LoadAll LA1500-PRO.
The high-capacity trolley to transport large quantities
of sheet materials.

**Please read this operational and maintenance
manual carefully prior to setting up the LoadAll.**

Contents

Safety information	4
Product specification	5
What's included	6
Getting to know your LoadAll	7
Using the LA1500-PRO	8
Using the handles on LA1500-PRO	9
Using the crane lifting eyes	10
Loading the LA1500-PRO	11
Storing the unit	12
Transporting the unit	13
Equipment care	14
Ongoing maintenance	14
Warranty	15
Spare parts	15



Safety information

- » Before using the LoadAll, ensure any relevant risk assessments are carried out. Armorgard cannot be responsible for accidents that occur due to negligence.
- » There are several possible finger trap locations, especially around the extending handles on LA1500-PRO. All personnel must be made aware to take care when using the LoadAll.
- » The LoadAll is too heavy to be safely lifted by one person. Carry out a risk assessment before lifting or lowering the LoadAll to ensure there is no risk of injury.
- » Ensure that the LoadAll is not damaged before using it.
- » Improper dangerous activities performed using the LoadAll increases the risk of personal injury, please follow the stated instructions to prevent incidents.
- » Use both hands when manoeuvring the LoadAll, taking extra care on slopes.
- » The LoadAll LA1500-PRO has been tested and assigned a maximum weight loading of 1500kg. Do not exceed this at any time.
- » The load capacity is indicated on the product, however site conditions can restrict the amount of materials carried and this should be determined by a risk assessment before work starts.
- » Use the ratchet straps and anchor points to secure loads on LA1500-PRO.
- » For the LA1500-PRO, in case of the need to emergency stop, the handle should be released immediately and the trolley will come to a halt.
- » When extending the handles of the LA1500-PRO, both sides should be the same length.
- » Do not lift by forklift when unit is loaded.

Whilst every effort has been made to ensure this operational and maintenance manual covers every aspect needed to operate your product safely, please take care whilst using the product and always operate with caution. Always liaise with management personnel on site for any additional operational restrictions that you need to be aware of.

Do	Don't
✓ Load each side evenly with materials	✗ Unevenly load trolley
✓ Lift safely by crane	✗ Overload the trolley
✓ Lift safely by forklift	✗ Ignore finger trap points
✓ Strap down materials (LA1500-PRO)	✗ Leave with handle extended (LA1500-PRO)

Product specification

Product code	Description	Weight (kg)	External dimensions W x D x H (mm)
LA1500-PRO	1.5 tonne LoadAll PRO with SafeStop deadman braking system	155	2020 x 760 x 1710



What's included...



1x LoadAll LA1500-PRO

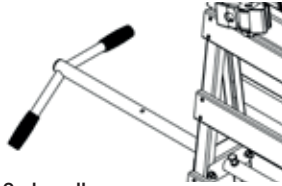

2x handle



4x M10 Button Head
Screw, M10 Washer and
M10 Nylock Nut

Getting to know your LoadAll™

The high-capacity trolley to transport large quantities of sheet materials

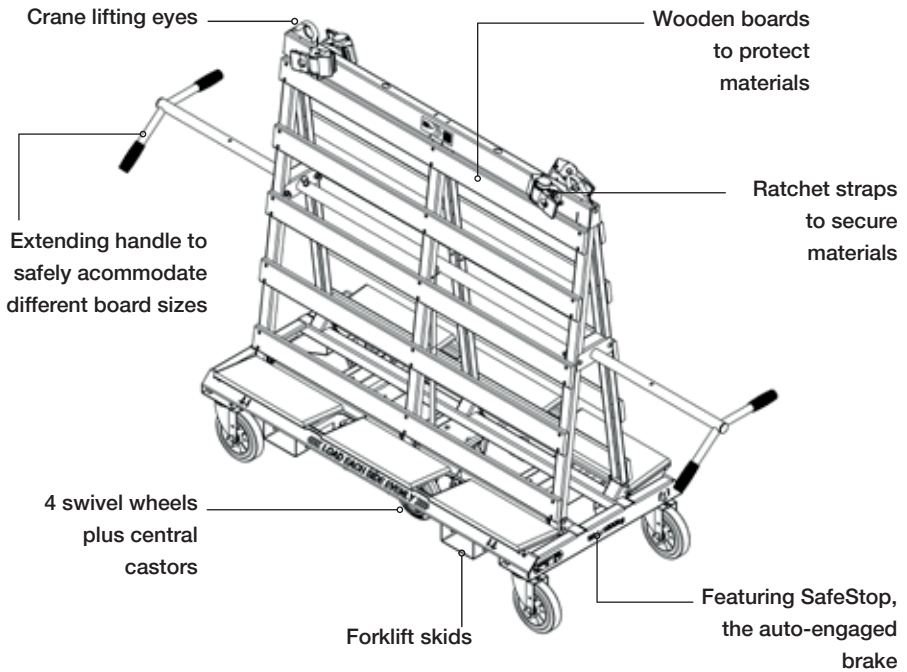

Working load limit



Forklift skids



SafeStop brake system



Crane lifting eyes



Lashing points



Using the LA1500-PRO

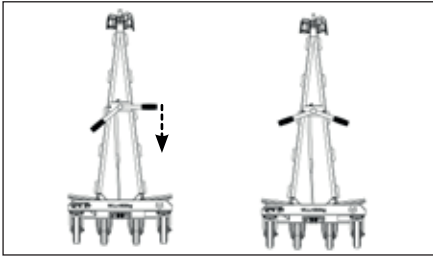

- 1.** In order to release the auto-engaged brake, rotate the handle bars so each handle is at the same height. Freely push your LoadAll. When you release the grip or let go of the handles, it will spring back to its original position and brakes will be applied.

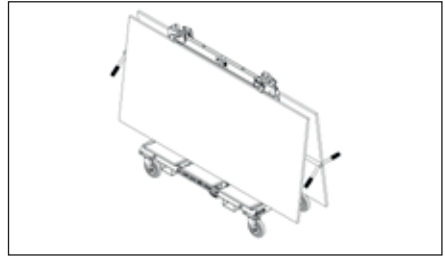

- 2.** Adjust handles to suit board length. There are three settings for board widths up to 1800mm, 2500mm and 3000mm, and height of 1200mm. Ensure to load both sides evenly and have the handles at the same length.

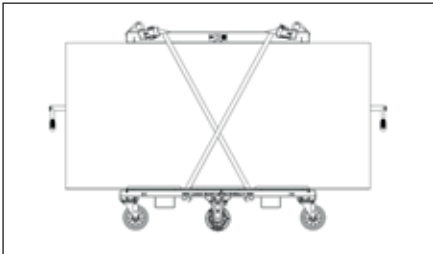

- 3.** Once loaded, strap the boards to the trolley using all four ratchet straps. Once straps are hooked in position, tighten until the straps are taut. Do not over tighten as this could damage the panel.

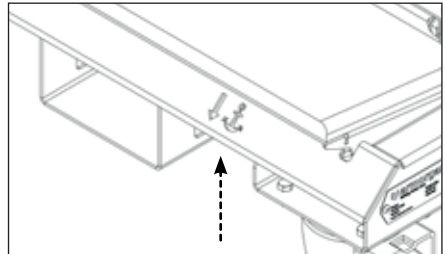

- 4.** If you fully load the trolley and the inner straps aren't accessible, use the anchor point as shown.



- 5.** Do not exceed the maximum ramp angle of 10 degrees.

Using the handles

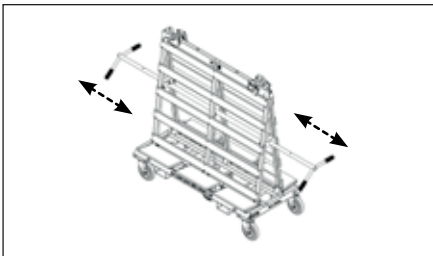

- 1.** Adjust the handles to the appropriate setting depending on the width of the boards being loaded. There are three settings to accommodate for boards of widths up to 1800mm, 2500mm and 3000mm.

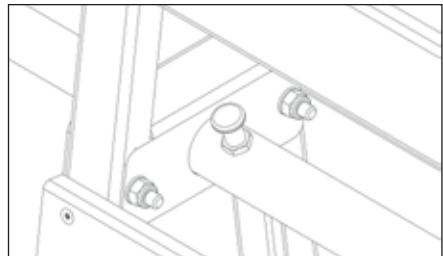

- 2.** To adjust the handles, simply pull the plunger located inside the trolley, then pull or push the handle into position. Ensure the plunger engages with one of the three available holes.



Using the crane lifting eyes

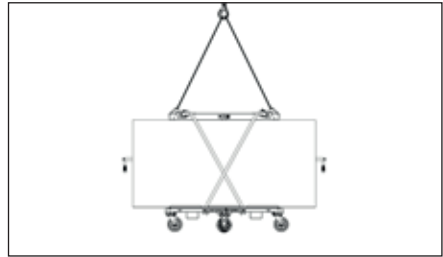
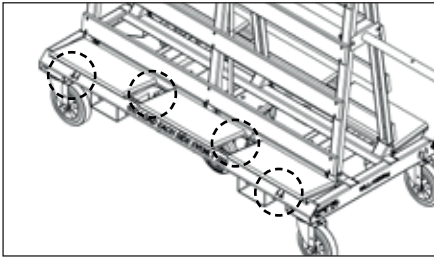

1. Check the unit is strapped and the load is secure using the fixing points indicated above. Ensure the material is evenly distributed and does not exceed the working load limit. When lifting fragile boards, remove or secure any loose material that could fall during the lift. Unit must be thoroughly examined prior to lifting.

2. Attach a suitable 2 leg lifting chain or sling to the lifting points provided. Check that no persons are in the immediate area prior to lifting.

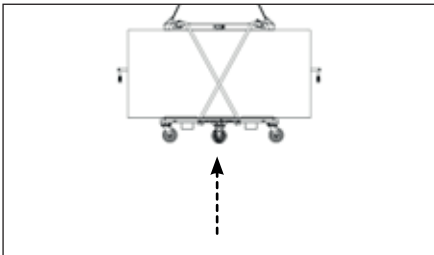

3. Carefully lift off the ground and check the unit is balanced. The trolley is now ready to lift to the new location.

4. Lower the unit at it's new location. Unhook the lifting chain or sling.

Loading the LA1500-PRO



- 1.** For panels taller than 1200mm, the ratchet straps would be obstructing the panel. Remove using a 7mm allen key.

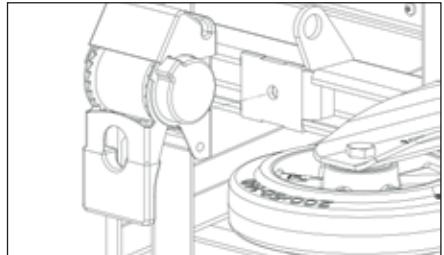

- 2.** For panels taller than 1200mm, the ratchet straps can be removed and re-attached to the base of the trolley. Do this safely by carefully placing the unit on its side, or raising it.

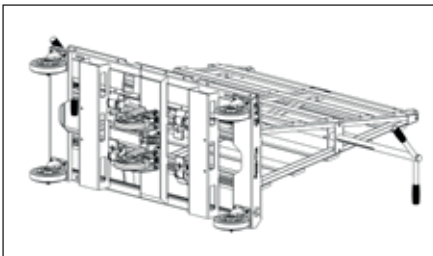

- 3.** Re-attach the ratchet straps with the trolley on its side. Always carry out a risk assessment when lifting the trolley.

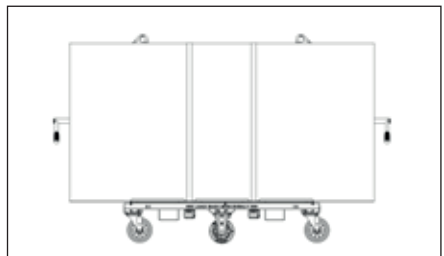

- 4.** Pull straps up and over the boards and hook into the holes provided in the top of the trolley.



Storing the unit

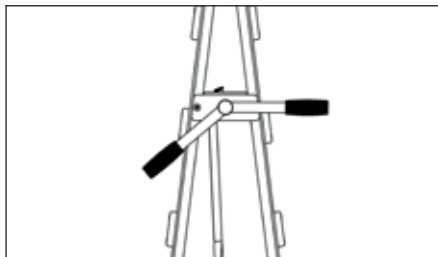

- 1.** On the LoadAll LA1500-PRO, ensure that nothing is leaning against the handle that may deactivate the brake when storing.

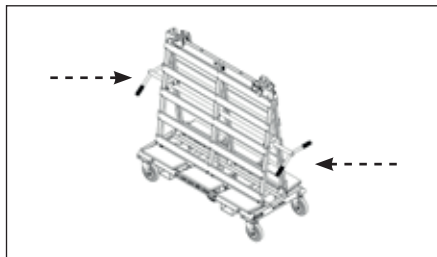

- 2.** When storing the LoadAll LA1500-PRO, the arms of the unit must be set to their shortest length so they do not pose as trip hazards.

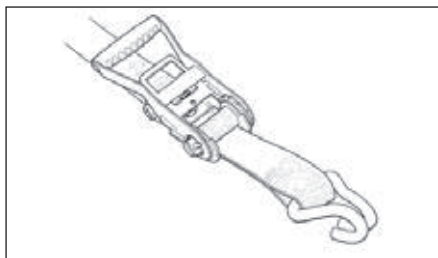

- 3.** When storing, always ensure that any materials are safely strapped to the unit.

Transporting the unit

The LoadAll has been designed specifically to make transporting the product easy.

The unit comes with forklift pockets for transporting using a forklift or pallet truck. It also comes with castors to make manoeuvring easy. On the LoadAll LA1500-PRO, The SafeStop auto-engaged braking system means that the unit remains static as long as the handles are not being used.

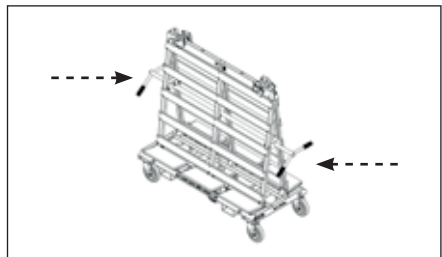
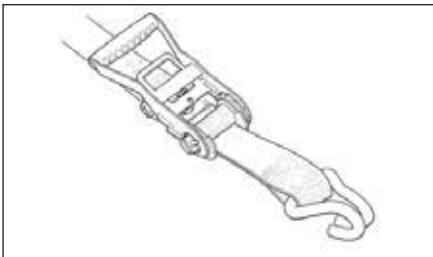

1. Always ensure that during transport, the product is secured to the carrier using straps or other appropriate measures.

2. When transporting the LoadAll LA1500-PRO, the arms of the unit must be set to their shortest length.



Equipment care

The LoadAll is weather resistant and constructed with a durable powder coated finish, so it is suitable for outdoor use, however it does not mean it is waterproof. It is important to note that any boards and materials susceptible to water damage should be sealed/covered.

Always ensure that the product dataplate remains visible and in good condition, especially the unique serial number.

Ongoing maintenance

It is important to check that the LoadAll is not damaged before every use.

We recommend for you to check the castors, handles, bolts, and straps every three months, to ensure that the LoadAll can operate fully. If the LoadAll will be under rigorous use, we recommend integrity checking regularly.

Always carry out integrity checks before lifting the LoadAll LA1500-PRO.

Warranty

Armorgard products are built to last, and all have a manufacturer's warranty of 12 months - please refer to the terms and conditions for what this covers.

Spare parts



Castor kit



Index plunger



Wood kit



Ratchet strap

Other spare parts available. Please get in touch for more information.



For additional support and easy access to spare or replacement parts, register your product following the QR code:



Version: 130325



Find us on social media:



UK Head Office

Unit 14-16, Standard Way, Fareham Industrial Park, Fareham, Hampshire, PO16 8XB
+44 (0) 23 9238 0280 | sales@armorgard.co.uk | www.armorgard.co.uk

France Office

+ 33 (0) 4 81 16 06 69
commercial@armorgard.fr
www.armorgard.fr

North America Office

1-877-794-2848
info@armorgardusa.com
www.armorgardusa.com