

SPARE PARTS GUIDE

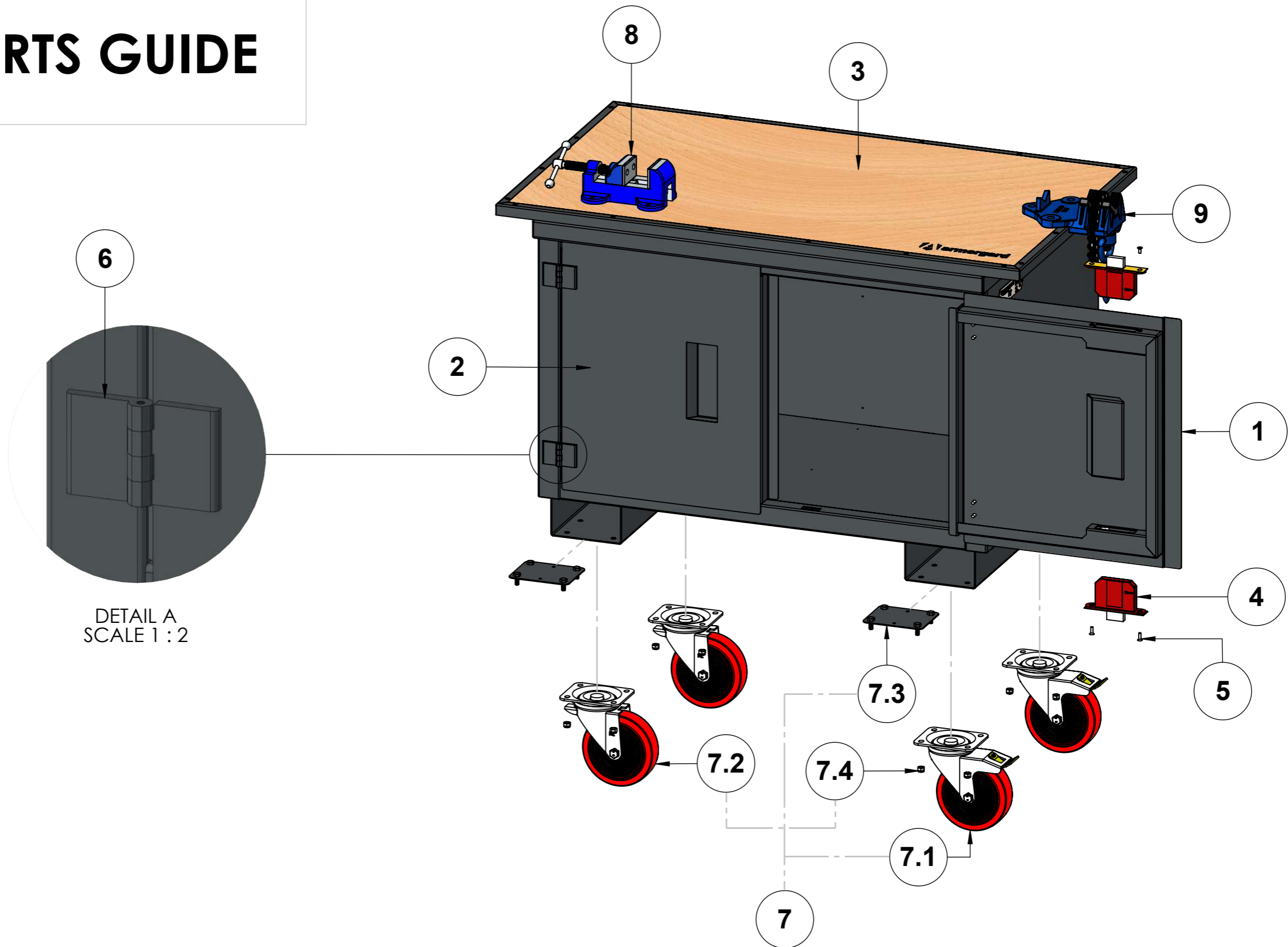

PRODUCT NAME:
**MOBILE TUFFBENCH -
MBH12 & MBH12-VF**

PRODUCT VERSION: T01
WEIGHT: 80kg

NOTES:

LAST DATE SAVED:
04/11/2024







THIS DRAWING MAY NOT BE COPIED, PUBLISHED OR TRANSMITTED TO A THIRD PARTY WITHOUT THE PRIOR WRITTEN CONSENT OF ARMORGARD LIMITED.

SPARE PARTS GUIDE

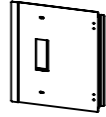
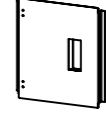
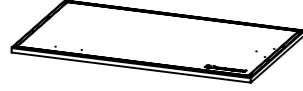
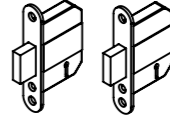
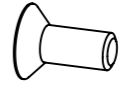
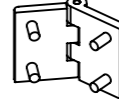
PRODUCT COLOUR:
RAL7021 DARK GREY

LEAD TIMES MAY VARY – PLEASE ENQUIRE

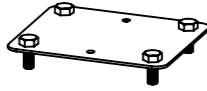
PAGE 1 of 2

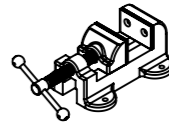
ITEM NO.	DESCRIPTION	PART #	REFERENCE IMAGE
1	MOBILE TUFFBENCH MBH-RHD RIGHT DOOR, BOLT-ON, EXCLUDES HINGES AND LOCKS	MBH-RHD	
2	MOBILE TUFFBENCH MBH-LHD LEFT DOOR, BOLT-ON, EXCLUDES HINGES AND LOCKS	MBH-LHD	
3	MOBILE TUFFBENCH MBH12-W WOODEN TOP WORK SURFACE	MBH12-W	
4	LOCK - PAIR OF 5-LEVER DEADLOCK, COMES WITH 4 KEYS	LOCK-DL2	
5	BOLT - M5X16 SOCKET COUNTERSUNK SCREW, ZINC PLATED (HIGH TENSILE GRADE 10.9)	BLT-M5x16-H	
6	HINGE - M6 BOLT-ON, ALUMINIUM, BLACK, 76MM	HNG-76B	
7	CASTER SET - 160mm RED HD WHEELS: 2X SWIVEL BRAKED, 2X SWIVEL; 4X CASTER PLATES, 16X M8 NYLOCS	CASHD2	
7.1	CASTOR - 160mm RED HD RUBBER ON NYLON, SWIVEL BRAKED, 350KG CAPACITY	CAS160HD-SS-SB	
7.2	CASTOR - 160mm RED HD RUBBER ON NYLON, SWIVEL, 350KG CAPACITY	CAS160HD-SS-SW	
7.3	CASTOR - FIXING PLATE	CAS-CP	
7.4	FIXING KIT - COMES WITH 16X M8 NYLOCS	M8-NUT-KIT	
8	VICE - 6" ENGINEERS' VICE	EV6	
9	VICE - 4" CHAIN VICE	CV4	