

SPARE PARTS GUIDE

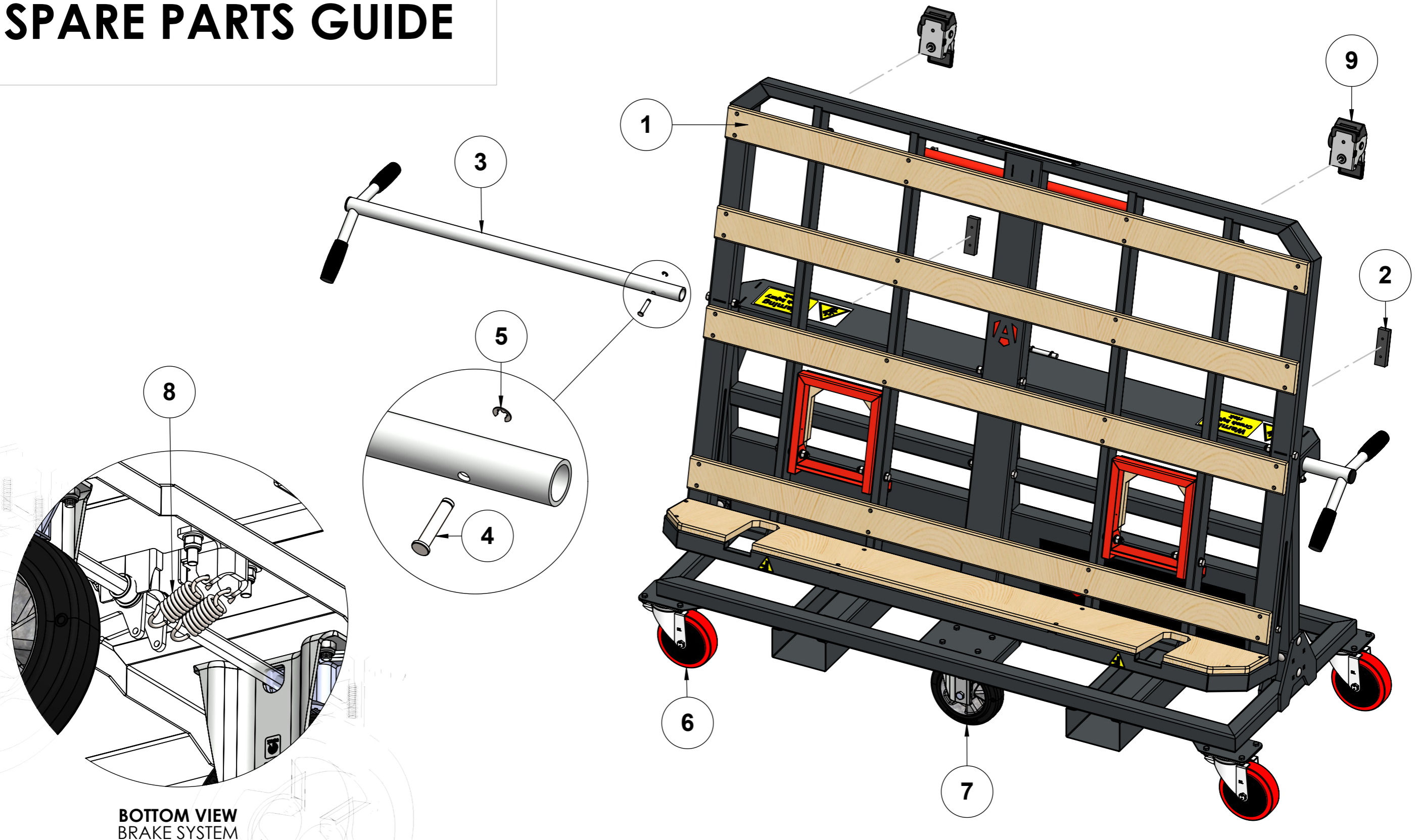

**BOTTOM VIEW
BRAKE SYSTEM**



PRODUCT NAME:
**ADAPTAKART -
AK750 & AK750OR**

PRODUCT VERSION: P04
WEIGHT: 155KG

NOTES:

LAST DATE SAVED:

13/03/2025



THIS DRAWING MAY NOT BE COPIED, PUBLISHED OR TRANSMITTED TO A THIRD PARTY WITHOUT THE PRIOR WRITTEN CONSENT OF ARMORGARD LIMITED.

SPARE PARTS GUIDE

PRODUCT COLOUR:
RAL7021 DARK GREY &
RAL2004 ORANGE

LEAD TIMES MAY VARY – PLEASE ENQUIRE

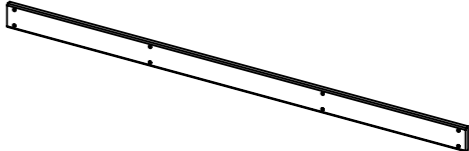
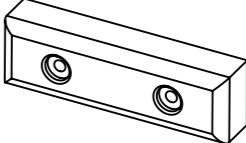
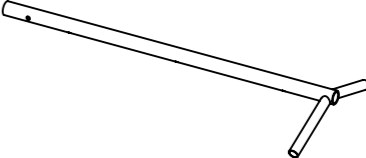
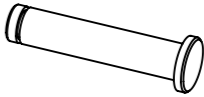
PAGE 1 of 2

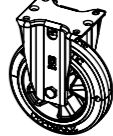
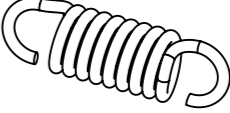
ITEM NO.	DESCRIPTION	PART #	REFERENCE IMAGE
1	ADAPTAKART AK750-WBK WOODEN BOARD KIT, COMES WITH 7X WOODEN SLATS AND FIXINGS	AK750-WBK	
2	SOLID RUBBER BLOCK 1000W X 20D X 30H	RBX-1	
3	ADAPTAKART AK750-HDL HANDLE, ONE SIDE	AK750-HDL	
4	CLEVIS PIN - 10X50MM, BZP STEEL WITH 45MM GRIP LENGTH WITH CIRCLIP GROOVE	PIN-CP10-50	
5	CIRCLIP / E-CLIP - M10 INTERNAL DIAMETER	CIRCLIP-10	
6	CASTOR - 160mm RED HD RUBBER ON NYLON, SWIVEL, 350KG CAPACITY	CAS160HD-SS-SW	
7	CASTOR - 200mm BLACK RUBBER ON ALUMINIUM, DEADMAN BRAKED, 500KG CAPACITY	CAS200-SS-DB	
8	EXTENSION SPRING - ZINC COATED, 19mm RATE 27.9Nmm L57mm (LE125G02)	SPRG-1957	
9	RATCHET STRAP - AUTO-RETRACTABLE, COMES WITH FIXINGS, 1500KG 3m X 50mm	RTCH-STP3-50-K	