





SPARE PARTS GUIDE

ITEM NO.	DESCRIPTION	PART #	REFERENCE IMAGE
1	LOCK - SINGLE LOCK FOR SAFESTOR (2023 ONWARDS), COMES WITH 2 KEYS, EXCLUDES LOCK RODS	LOCK-HFC	
2	PLUG - BLACK PLASTIC ACCESSORY FOR TOP-BOTTOM LOCKING BAR BRIDGE	HFC-PLG1	
3	SHELF - COMES WITH BRACKETS, FOR HFC1, HFC3, HFC5, HFC7, HMC1, HMC2	SHE-HFC-C	
4	SHELF - BRACKET ONLY, FOR SAFESTOR RANGE	SHE-HCF-CLP	
5	SAFESTOR M8FT-1 ADJUSTABLE END FOOT M8X25MM	M8FT-1	
6	CASTOR SET- 75MM WHEELS; 2X SWIVEL BRAKED, 2X SWIVEL; 4X M10X30 BOLTS, 4X M10 WASHERS, 4X M10 NYLOCS	CASS6	
7	SAFESTOR HFC2 STAND, FOR HFC1, HFC3, HFC5, 916W X 487D X 537H	HCS2	
8	KEY - SINGLE, FOR SAFESTOR	KEY-HFC	

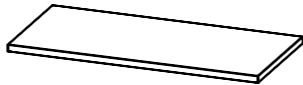
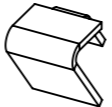
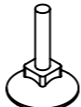

PRODUCT NAME:
SAFESTOR - HFC1

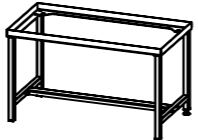
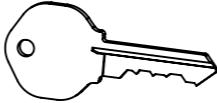
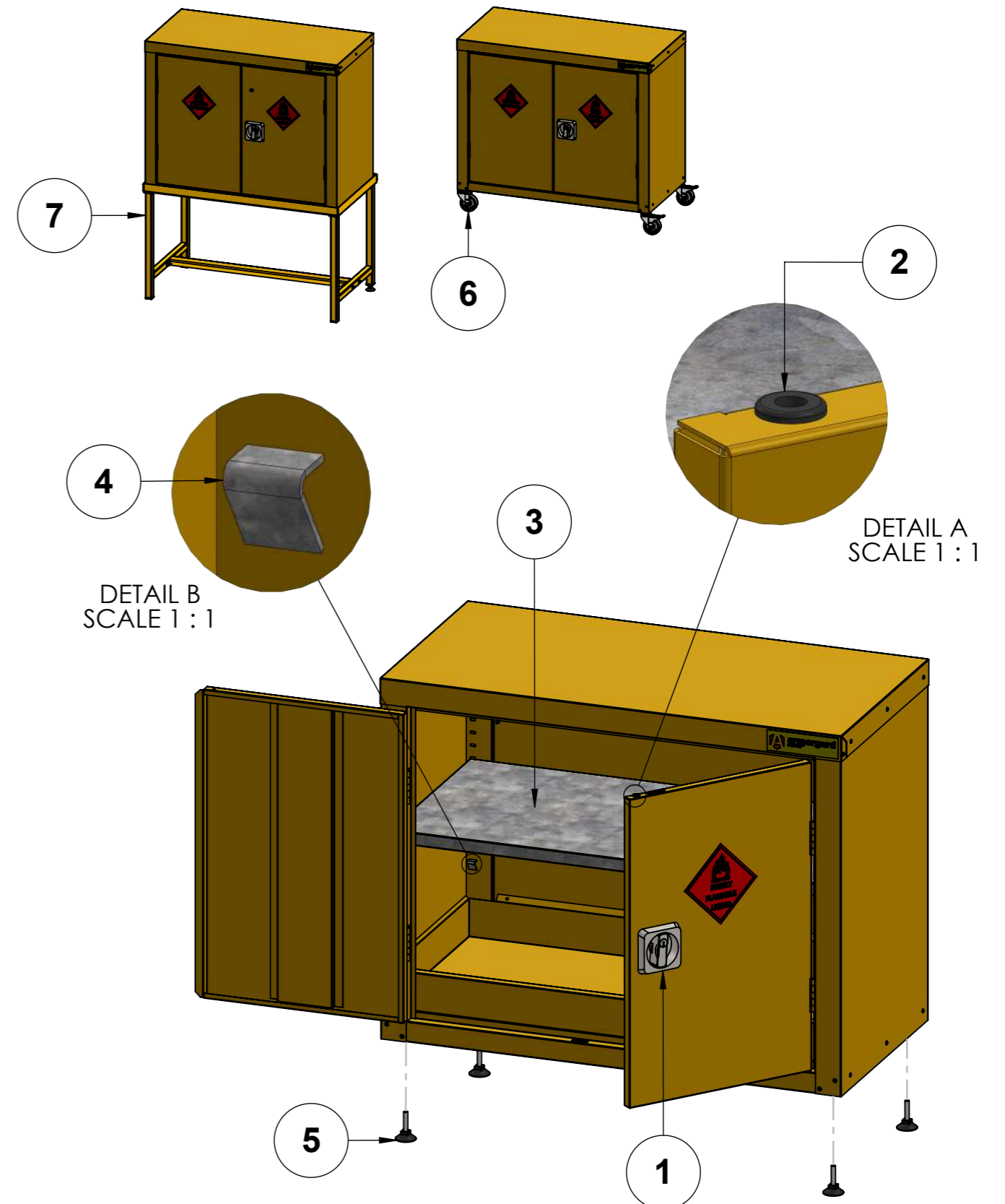
PRODUCT VERSION:
P01

WEIGHT:
30kg

NOTES:

LAST DATE SAVED:

18/11/2024

THIS DRAWING MAY NOT BE COPIED, PUBLISHED OR TRANSMITTED TO A THIRD PARTY WITHOUT THE PRIOR WRITTEN CONSENT OF ARMORGARD LIMITED.

SPARE PARTS GUIDE

PRODUCT COLOUR:
RAL1023 YELLOW

LEAD TIMES MAY VARY – PLEASE ENQUIRE

PAGE 1 of 1