







# SPARE PARTS GUIDE

| ITEM NO. | DESCRIPTION   | PART #       | REFERENCE IMAGE   |
|----------|---|--------------|---|
| 1        | LOCK - SINGLE LOCK FOR SAFESTOR (2023 ONWARDS), COMES WITH 2 KEYS, EXCLUDES LOCK RODS | LOCK-HFC     |    |
| 2        | PLUG - BLACK PLASTIC ACCESSORY FOR TOP-BOTTOM LOCKING BAR BRIDGE                      | HFC-PLG1     |    |
| 3        | SHELF - COMES WITH BRACKETS, FOR HFC1, HFC3, HFC5, HFC7, HMC1, HMC2                   | SHE-HFC-C    |   |
| 4        | SHELF - BRACKET ONLY, FOR SAFESTOR RANGE  | SHE-HCF-CLP  |  |
| 5        | CASTOR - 75MM PLAIN SWIVEL, M10 BOLT HOLE, 70KG CAPACITY                              | CAS75-SS-SW  |  |
| 6        | CASTOR - 75MM PLAIN SWIVEL BRAKED, M10 BOLT HOLE, 70KG CAPACITY                       | CAS75-SS-SWB |  |
| 7        | KEY - SINGLE, FOR SAFESTOR  | KEY-HFC      |  |

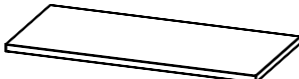
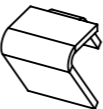

PRODUCT NAME:  
**SAFESTOR - HMC1**

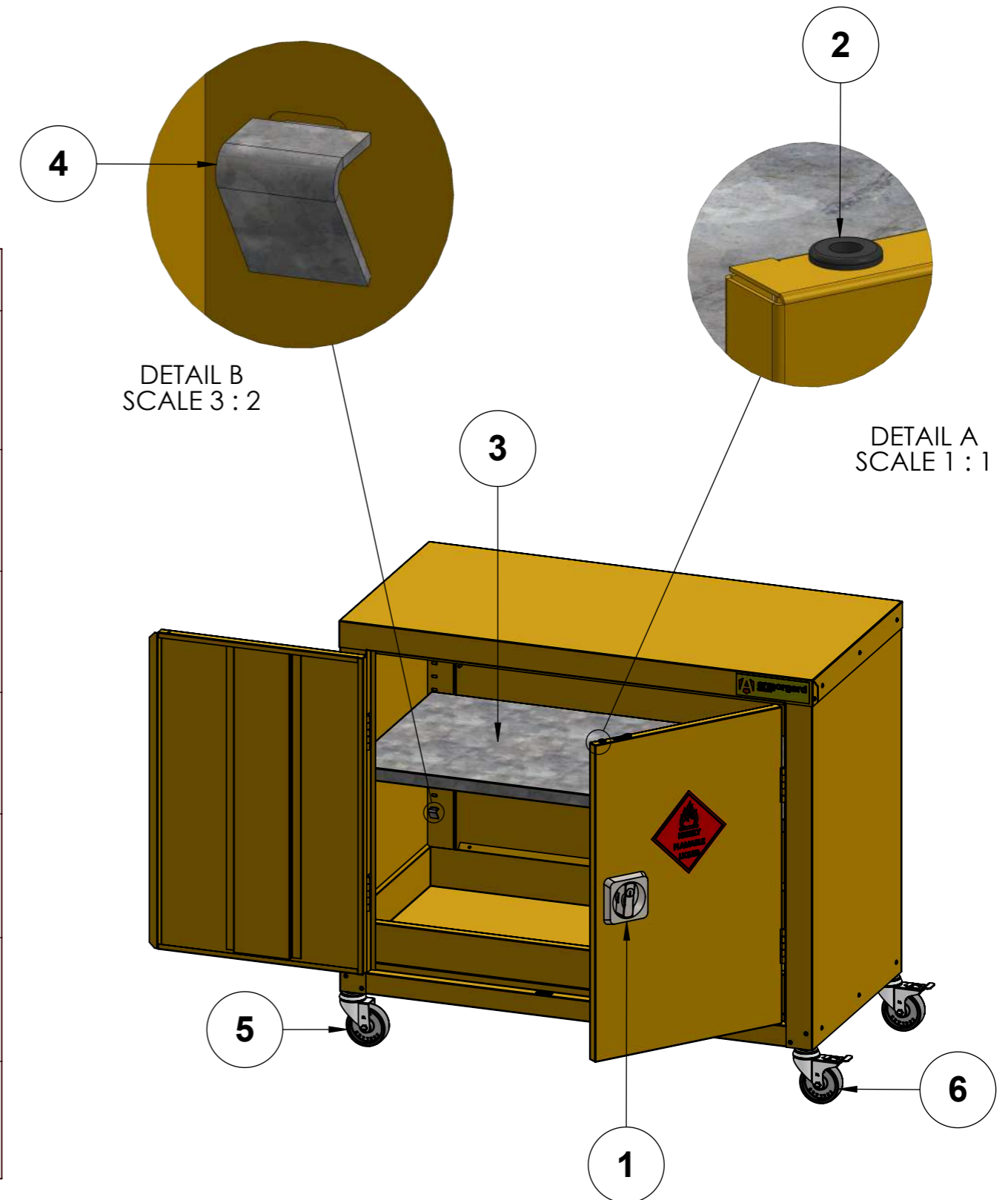
PRODUCT VERSION:  
P01

WEIGHT:  
34kg

NOTES:

LAST DATE SAVED:

18/11/2024

THIS DRAWING MAY NOT BE COPIED, PUBLISHED OR TRANSMITTED TO A THIRD PARTY WITHOUT THE PRIOR WRITTEN CONSENT OF ARMORGARD LIMITED.

SPARE PARTS GUIDE

PRODUCT COLOUR:  
RAL1023 YELLOW

LEAD TIMES MAY VARY – PLEASE ENQUIRE

**PAGE 1 of 1**