

SPARE PARTS GUIDE

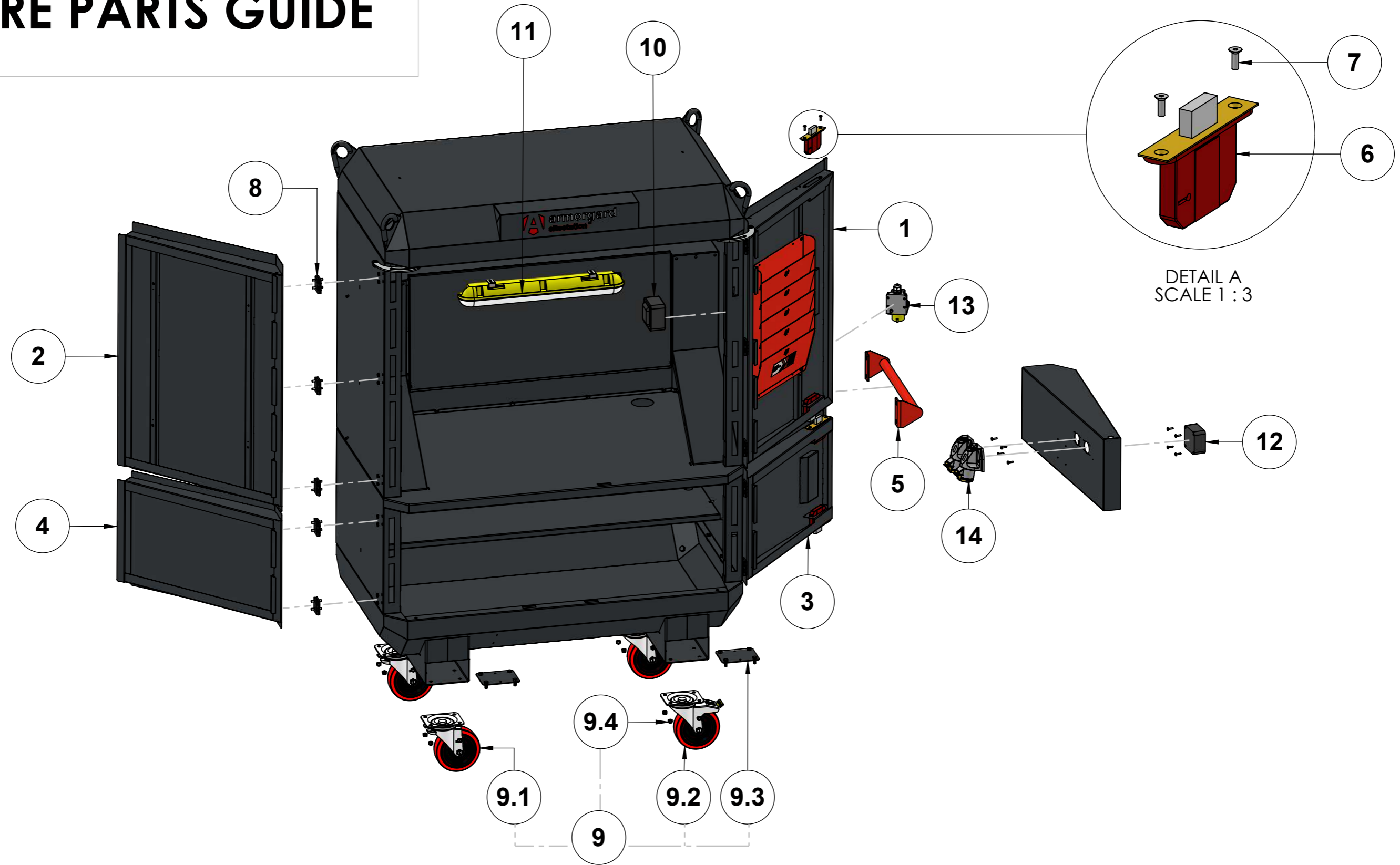

PRODUCT NAME:
SITESTATION - SS2

PRODUCT VERSION: T03
WEIGHT: 230KG

NOTES:

LAST DATE SAVED:
18/02/2026



THIS DRAWING MAY NOT BE COPIED, PUBLISHED OR TRANSMITTED TO A THIRD PARTY WITHOUT THE PRIOR WRITTEN CONSENT OF ARMORGARD LIMITED.



SPARE PARTS GUIDE

PRODUCT COLOUR:
RAL7021 DARK GREY

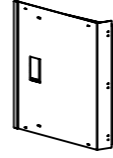
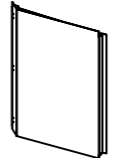
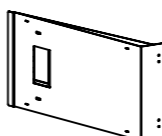
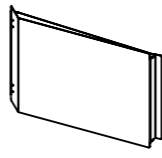
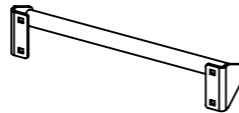
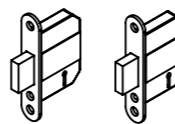
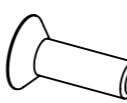
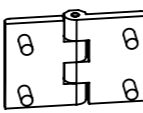
LEAD TIMES MAY VARY – PLEASE ENQUIRE

PAGE 1 of 2

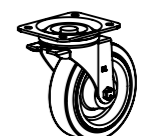
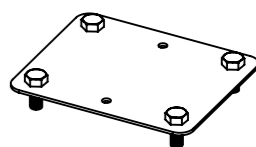
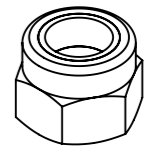
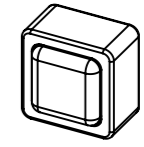
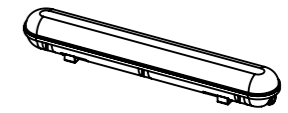
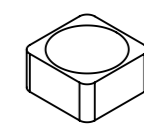
ITEM NO.	DESCRIPTION	PART #	REFERENCE IMAGE
1	SITESTATION SS2-URHD UPPER RIGHT REPLACEMENT DOOR, BOLT-ON, EXCLUDES HINGES AND LOCKS	SS2-URHD	
2	SITESTATION SS2-ULHD UPPER LEFT REPLACEMENT DOOR, BOLT-ON, EXCLUDES HINGES AND LOCKS	SS2-ULHD	
3	SITESTATION SS2-LRHD LOWER RIGHT REPLACEMENT DOOR, BOLT-ON, EXCLUDES HINGES AND LOCKS	SS2-LRHD	
4	SITESTATION SS2-LLHD LOWER LEFT REPLACEMENT DOOR, BOLT-ON, EXCLUDES HINGES AND LOCKS	SS2-LLHD	
5	HANDLE - RED STEEL, BOLT-ON, EXCLUDES FIXINGS, 480W X 90D X 100H	HAN-480-B	
6	LOCK - PAIR OF 5-LEVER DEADLOCK, COMES WITH 4 KEYS	LOCK-DL2	
7	BOLT- M5X16 SOCKET COUNTERSUNK SCREW, ZINC PLATED (HIGH TENSILE GRADE 10.9)	BLT-M5X16-H	
8	HINGE - M6 BOLT-ON, ALUMINIUM, BLACK, 76mm; (EXCLUDES M6 NYLOCS)	HNG-76B	
9	CASTOR SET - 160mm RED HD WHEELS: 2X SWIVEL BRAKED, 2X SWIVEL; 4X CASTOR PLATES, 16X M8 NYLOCS	CASHD2	

ITEM NO.	DESCRIPTION	PART #	REFERENCE IMAGE
9.1	CASTOR - 160mm RED HD RUBBER ON NYLON, SWIVEL BRAKED, 350KG CAPACITY	CAS160HD-SS-SB	
9.2	CASTOR - 160mm RED HD RUBBER ON NYLON, SWIVEL, 350KG CAPACITY	CAS160HD-SS-SW	
9.3	CASTOR - FIXING PLATE	CAS-CP	
9.4	FIXING KIT - COMES WITH 16X M8 NYLOCS	M8-NUT-KIT	
10	SWITCH - 10A, 1 GANG DOUBLE POLE SWITCH, IP66 - UK/EU	SWT-01	
11	LIGHT - 110V LED NCF IP65 600mm	LED600	
12	JUNCTION BOX - BLACK, 32A, IP66 85X85X51MM	JB-1G	
13	APPLIANCE INLET - 110V 16A YELLOW	AI110V	
14	SOCKET - 3-PIN 16A 110V ANGLED, YELLOW	SOC-110-COM-A	