

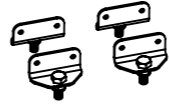

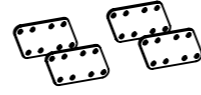

SPARE PARTS GUIDE

ITEM NO.	DESCRIPTION	PART #	REFERENCE IMAGE
1	TREKDROR TKDMPK MOUNTING PLATE KIT	TKDMPK	
2	TREKDROR TKDSPK STACKING PLATE KIT	TKDSPK	
3	TREKDROR TKD2D DIVIDER KIT, SET OF 3 FOR TKD2	TKD2D	
4	TREKDROR TKD2-RM RUBBER MAT FOR TKD2	TKD2-RM	
5	FIXING KIT - COMES WITH 8X M6X20 HEX HEAD SCREW	M6-BLT-KIT	
6	LOCK - PAIR OF 5-LEVER DEADLOCK, COMES WITH 4 KEYS	LOCK-DL2	
7	BOLT- M5X16 SOCKET COUNTERSUNK SCREW, ZINC PLATED (HIGH TENSILE GRADE 10.9)	BLT-M5X16-H	
8	KEY- SINGLE, FOR DEADLOCK	KEY-1	
9	KEY- SET OF 3, FOR DEADLOCK	KEY-3	

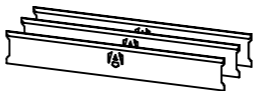

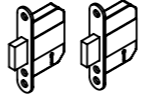
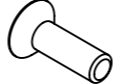
PRODUCT NAME:
TREKDROR - TKD2

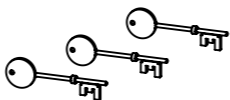
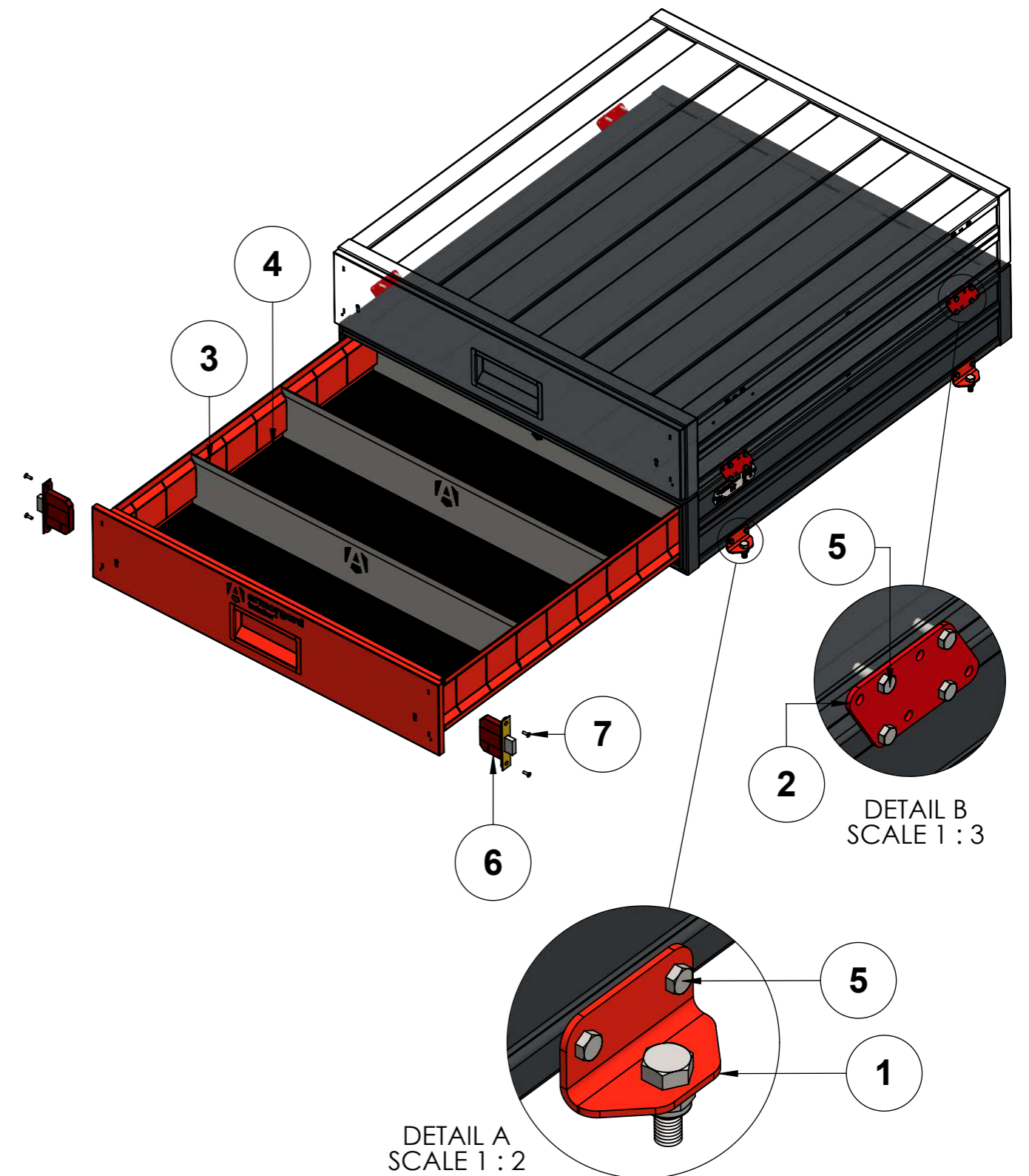
PRODUCT VERSION:
P03

WEIGHT:
60KG

NOTES:

LAST DATE SAVED:

08/10/2024

THIS DRAWING MAY NOT BE COPIED, PUBLISHED OR TRANSMITTED TO A THIRD PARTY WITHOUT THE PRIOR WRITTEN CONSENT OF ARMORGARD LIMITED.

SPARE PARTS GUIDE

PRODUCT COLOUR:
RAL7021 DARK GREY &
RAL3020 RED

LEAD TIMES MAY VARY – PLEASE ENQUIRE

PAGE 1 of 1