

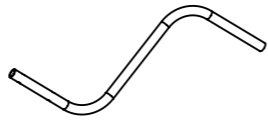

# SPARE PARTS GUIDE

ITEM NO.	DESCRIPTION	PART #	REFERENCE IMAGE
1	V-KART VK2 TUBULAR HANDLE FOR KART 600X425X25	VK2-HAN	
2	HANDLE - BLACK RUBBER GRIP HANDLE, 100MM LENGTH, 25MM DIAMETER	HAN-GRP-25X110	
3	SOLID RUBBER BLOCK 1000W X 20D X 30H	RBX-1	
4	1500KG AUTO-RETRACTABLE RATCHET STRAP 3m X 50mm WITH FIXING KIT	RTCH-STP3-50-k	
5	WHEEL - 350MM BLACK RUBBER ON RED STEEL, 300KG CAPACITY	WHL350	
6	WASHER - FLAT M27, BZP STEEL	WAS-M27-F	
7	WASHER - STAR CAP CLOSED RETAINER M25, (FOR AXLES)	WAS-M25-C	

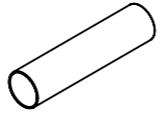
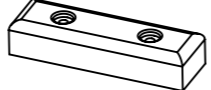
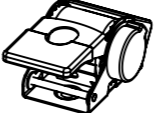
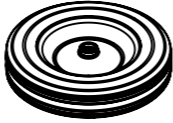
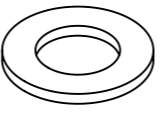

PRODUCT NAME:

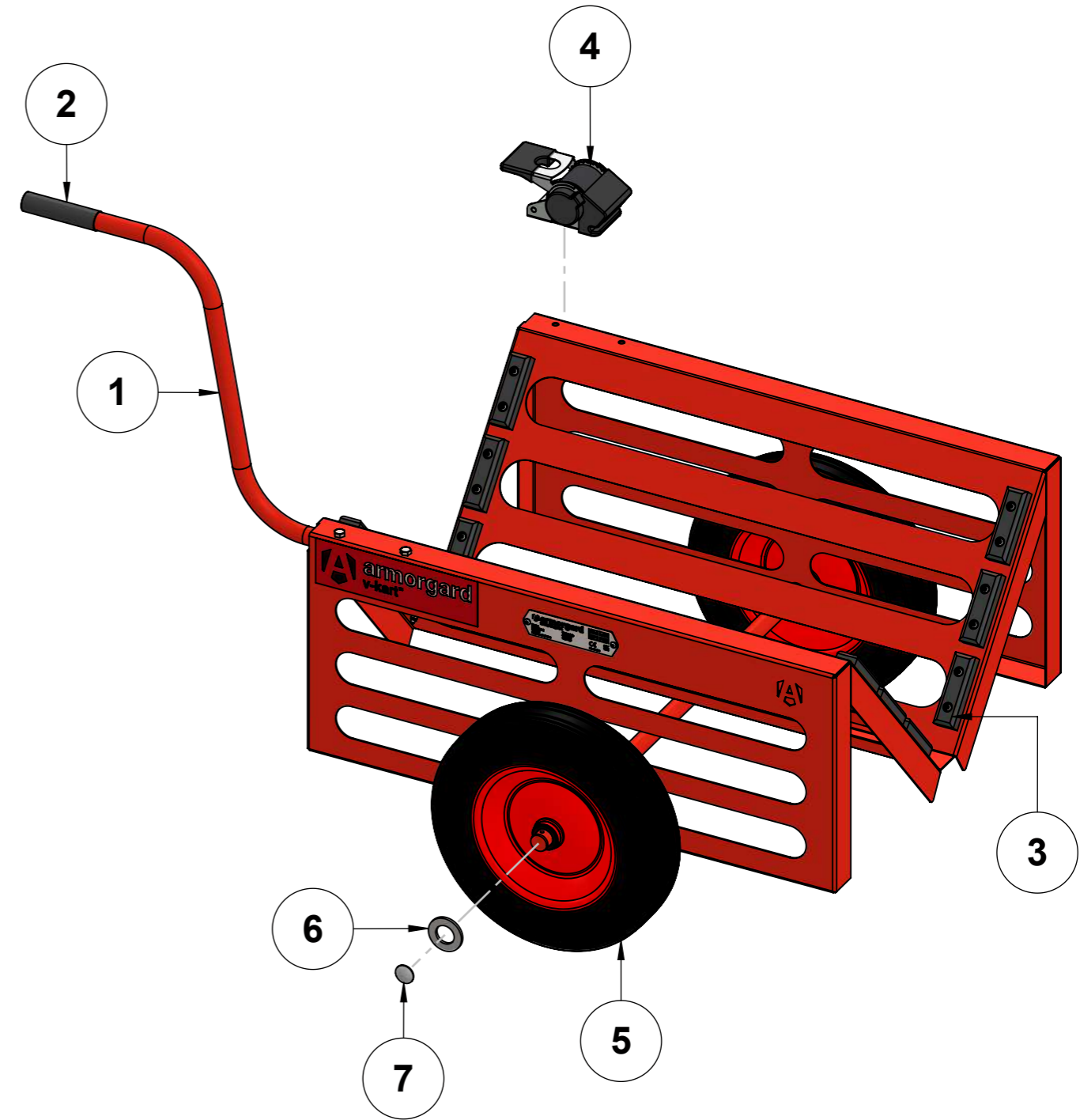
**V-KART - VK2**

PRODUCT VERSION:

P01

WEIGHT:

34kg

NOTES:

LAST DATE SAVED:

30/10/2024

THIS DRAWING MAY NOT BE COPIED, PUBLISHED OR TRANSMITTED TO A THIRD PARTY WITHOUT THE PRIOR WRITTEN CONSENT OF ARMORGARD LIMITED.

SPARE PARTS GUIDE

PRODUCT COLOUR:

RAL3020 RED

LEAD TIMES MAY VARY – PLEASE ENQUIRE

**PAGE 1 of 1**